

LAQUA Twin EC Meter

PRODUCT MANUAL

Item 2205L



Spectrum[®]
Technologies, Inc.

This manual will familiarize you with the features and operation of your new meter. Please read this manual thoroughly before using your meter. For customer support or to place an order call:

Spectrum Technologies, Inc.
(800)248-8873 or (815) 436-4440
between 7:30 am and 5:30 pm CST
FAX (815) 436-4460,
e-mail: info@specmeters.com
www.specmeters.com
Spectrum Technologies, Inc
3600 Thayer Court
Aurora, IL 60504

Replacement Parts:

Item 2210 - Conductivity Standard, 1.41 mS/cm (6 - 14 mL bottles)

Item 2242L - LAQUA Twin EC Meter Replacement Sensor

GENERAL OVERVIEW

Thank you for purchasing the LAQUA Twin EC Meter from Spectrum Technologies. This meter is ideal for water quality and greenhouse applications.

Features:

- “Professional Grade” Meter
- Ultra-slim meter features push-button auto-calibration and automatic temperature compensation
- Waterproof packet-sized meter with digital calibration
- Accurately measures even a single drop of saturated media extract
- Accuracy of $\pm 2\%$
- Includes two CR2032 batteries, case and solution standard

The Quick Start Guide follows the Specifications in the manual. Following that is the manual produced by the manufacturer of the LAQUA Twin EC Meter.

8.2 Specifications

| | | |
|-------------------------------------|--------------|--|
| Model | | B-771 |
| Measurement principle | | 2 AC bipolar method |
| Minimum sample volume | | 0.12 mL or more |
| Measurement range | Conductivity | 0 mS/cm to 19.9 mS/cm, 0 S/m to 1.99 S/m |
| | Salt | 0% to 1.1% |
| | TDS | 0 ppm to 9900 ppm |
| Display range | | 0 mS/cm to 199 mS/cm (0 S/m to 19.9 S/m) ^{*1} |
| Range and resolution (valid digits) | | (1) 0 μ S/cm to 199 μ S/cm: 1 μ S/cm (2) 0.20 mS/cm to 1.99 mS/cm: 0.01 mS/cm (3) 2.0 mS/cm to 19.9 mS/cm: 0.1 mS/cm (4) 20 mS/cm to 199 mS/cm: 1 mS/cm |
| Calibration | | Two-point ^{*2} |
| Accuracy | | $\pm 2\%$ full scale ± 1 digit (for each range) ^{*3} |
| Display | | Custom (monochrome) digital LCD |
| Operating temperature/humidity | | 5°C to 40°C, 85% or less in relative humidity (no condensation) |
| Power | | CR2032 batteries ($\times 2$) |
| Battery life | | Approx. 400 hours in continuous use |
| Main materials | | ABS epoxy |
| Outer dimensions/mass | | 164 mm \times 29 mm \times 20 mm (excluding projections) Approx. 45 g (meter only, without batteries) |
| Main functions | | Temperature conversion (2%/°C fixed), waterproof ^{*4} , reading locking, automatic power OFF |

- *1 When the measured value is out of the measurement range, the displayed value blinks. It should be used only as a guide.
- *2 Selectable between one-point and two-point calibrations.
The high conductivity standard solution (12.9 mS/cm) is sold separately.
- *3 Repeatability in measurement of a standard solution after calibration using the same standard solution.
(1) $\pm 5 \mu$ S/cm (0 μ S/cm to 199 μ S/cm), (2) ± 0.05 mS/cm (0.20 mS/cm to 1.99 mS/cm), (3) ± 0.5 mS/cm (2.0 mS/cm to 19.9 mS/cm), (4) ± 5 mS/cm (20 mS/cm to 199 mS/cm)
- *4 IP67: no failure when immersed in water at a depth of 1 meter for 30 minutes. But the product can not be used underwater.

Quick Operation Guide

This quick operation guide introduces the basic operations.
Refer to the respective chapters for further information.

① Electrode Surface Treatment

* Perform this before the first use and after a long storage.

- ① Put some drops of the moistening solution and let it sit still for approximately 10 minutes.
- ② Wash the sensor.



② Turn ON

Press the ON/OFF button over 2 seconds to turn ON the meter.

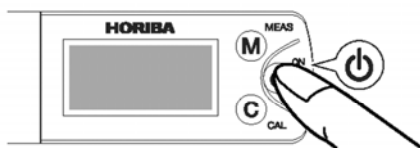

③ Calibration

Perform calibration at least once a day for accurate measurement.

- ① Pour the 1.41 mS/cm standard solution.
- ② Press the CAL button over 2 seconds. When **CAL** and ☺ light up, the calibration is completed.

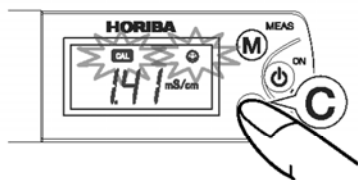
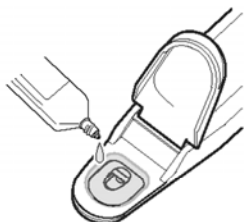

- ③ Clean the sensor with water.



- ④ Press the MEAS button to enter the measurement mode.

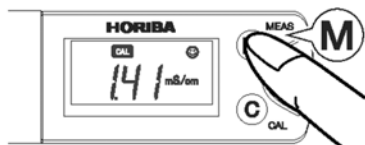

④ Measurement

① Pour some drops of sample.

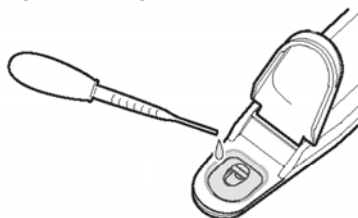

② When ☺ lights up, the measurement is completed.
To lock the measured value, press the MEAS button.



⑤ After Use

Clean the sensor with water,
and then turn OFF the power.
Close the protection cover before storage.
Make sure to store the sensor without any moisture.



The following settings can be changed.

- Measurement unit
- Calibration points
- Temperature/display

Two-point calibration is recommended for accurate measurement.
Prewashing the sensor with the sample may provide accurate measurement.

Refer to page 6 to page 19 for detailed instructions.

Contents

| | | |
|----------|--|-----------|
| 1 | Introduction | 1 |
| 1.1 | Items in package | 1 |
| 1.2 | Consumable parts sold separately | 1 |
| 2 | Part Names and Functions | 2 |
| 3 | Handling Precautions | 4 |
| 4 | Basic Handling | 6 |
| 4.1 | Inserting/removing batteries | 6 |
| 4.2 | Attaching/detaching the sensor | 7 |
| 4.3 | Power ON/OFF | 8 |
| 4.4 | Storage | 8 |
| 4.5 | Electrode surface treatment | 8 |
| 5 | Calibration | 9 |
| 5.1 | About calibration | 9 |
| 5.2 | One-point calibration | 10 |
| 5.3 | Two-point calibration | 11 |
| 6 | Measurement | 12 |
| 6.1 | Sample setting | 12 |
| 6.2 | Measurement operations | 14 |
| 7 | Special Setting Mode | 15 |
| 7.1 | Measurement unit setting | 16 |
| 7.2 | Temperature display mode | 17 |
| 7.3 | Calibration point setting | 18 |
| 7.4 | Initialization mode | 19 |
| 7.5 | Software version display mode | 19 |
| 8 | Appendix | 20 |
| 8.1 | Frequently asked questions | 20 |
| 8.2 | Specifications | ii |

1 Introduction

COMPACT CONDUCTIVITY METER B-771 incorporates HORIBA original flat sensor and enables accurate measurement of conductivity from a single drop of a sample.

B-771 can display converted salt concentrations and converted TDS (total dissolved solids) as well as conductivity.

1.1 Items in package

| Meter model | | B-771 |
|------------------------------|-------------------------|-------|
| Sensor | S070 | 1 |
| Meter | B-771 | 1 |
| Storage case | | 1 |
| Batteries | CR2032 | 2 |
| Dedicated standard solutions | Conductivity 1.41 mS/cm | 1 |
| Moistening solution | | 1 |
| Pipette | | 1 |
| Instruction manual | B-771 | 1 |
| Quick-start manual | | 1 |

Note

Before using the sensor for the first time, perform electrode surface treatment as instructed on page 8.

1.2 Consumable parts sold separately

| Part No. | Name | Type | Application |
|------------|--------------------|-------------------|---------------------------|
| 3200459672 | Sensor | S070, COND | B-771 |
| 3200457717 | Standard solutions | Y071L, 1.41 mS/cm | B-771 (low conductivity) |
| 3200457718 | | Y071H, 12.9 mS/cm | B-771 (high conductivity) |

2 Part Names and Functions

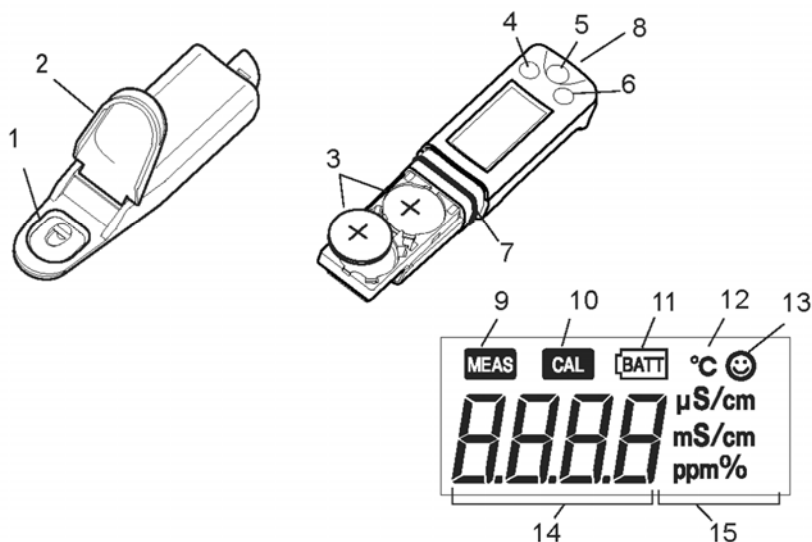

| No. | Name | Description |
|-----|-------------------|---|
| 1 | Measurement cell | Place a sample in this cell to measure it with the electrode located on the bottom of the cell. |
| 2 | Protection cover | Protects the measurement cell and flat sensor. |
| 3 | Lithium batteries | CR2032 (×2) |
| 4 | MEAS switch | Switches the calibration mode to the measurement mode, activates/deactivates the reading locking function in the measurement mode, and starts/applies settings in the special setting mode. |
| 5 | ON/OFF switch | Turns ON/OFF the meter. |
| 6 | CAL switch | Starts calibration, and switches items/settings in the special setting mode. |
| 7 | Waterproof gasket | Makes the meter waterproof. |
| 8 | Strap eyelet | A strap can be attached here. |

| No. | Name | Description |
|-----|--------------------------|---|
| 9 | MEAS icon | Blinks until the measured value is stabilized, and lights steadily when the measured value is settled, while the reading locking function is active. |
| 10 | CAL icon | Blinks during calibration, and lights steadily when calibration is finished. |
| 11 | Battery alarm icon | Lights up when the batteries are low and need to be changed. |
| 12 | Temperature alarm icon | Blinks when the measuring environment temperature does not meet the specified operating temperature (5°C to 40°C). |
| 13 | Stability icon | Lights up when the measured value is stabilized. |
| 14 | Measured value display | Displays a measured, set, or status value. |
| 15 | Measurement unit display | A unit symbol lights up corresponding to the value displayed on the measured value display (14). For conductivity, "S/cm" or "S/m" is selectable (refer to page 16). "%" lights up for converted salt concentrations, and "ppm" lights up for converted TDS. The default setting is "S/cm". |

3 Handling Precautions

■ Meter and sensor

- The sensor is a consumable part. If it becomes damaged or its performance deteriorates, replace it with a new one (the sensor can not be repaired).
- Do not swing the meter and sensor by holding a strap.
- To ensure the waterproof performance, confirm the followings when attaching the sensor.
 - The waterproofing gasket is clean and undamaged.
 - The waterproofing gasket is seated properly in the groove with no twisting or warping.
 - The meter and sensor are not deformed.
- Neither the meter nor sensor is waterproof by itself. The sensor must be securely mounted on the meter before use.
- Do not drop the meter or apply excessive force to it.



- Do not leave the meter in areas of direct sunlight or high temperature/humidity.
- Do not clean the meter with organic solvents.



- The surface of the electrode is treated specially. Take care not to touch it with anything.

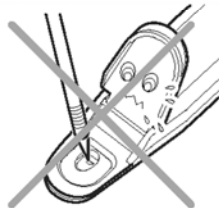

- Do not measure samples such as the following, since they may damage the sensor or shorten its life: Organic solvents, oils, adhesives, cement, alcohols, concentrated acid (0 pH to 2 pH), concentrated alkaline (12 pH to 14 pH) or solid materials.
- In the following cases, perform electrode surface treatment as instructed on page 8.
 - The sensor is used for the first time.
 - The sensor is slow to respond, after several weeks of disuse, etc.
 - The inside of the measurement cell is dirty.
 - Bubbles tend to occur inside the measurement cell.
 - The measured value is unstable.

Battery

- Keep batteries out of reach of children. If someone accidentally swallows a battery, call a doctor immediately.
- Do not throw batteries in fire.
- Do not attempt to recharge batteries.
- The provided batteries are intended for use in operation checking, therefore their service life may be short.
- The battery alarm icon lights up when the battery voltage is low. Replace the batteries when the battery alarm icon lights up. The meter power may not be turned ON/OFF when the battery voltage is low.
- Replace the 2 batteries at the same time.

Others

- Wash off any calibration fluid that comes into contact with hands or other exposed skin. If fluid gets in eyes, rinse them immediately and see a doctor.

4 Basic Handling

4.1 Inserting/removing batteries

Note

- Turn OFF the meter before inserting/removing batteries.
- Always replace both batteries at once. Do not use old and new batteries together.

Inserting the batteries

1. Slide both batteries into the battery case as shown.

Be sure to use two CR2032 batteries, and put them with the plus sides (+) upwards.

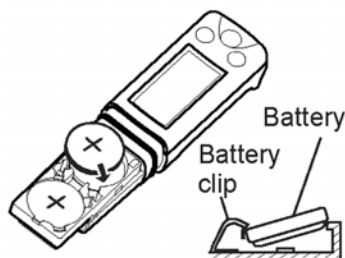

Removing the batteries

1. Use a ball-point pen or other tool to pry the batteries out from the clips as shown.

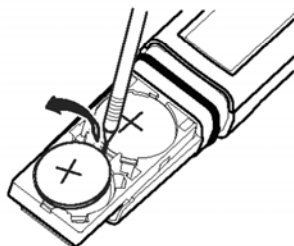

4.2 Attaching/detaching the sensor

Note

- Turn OFF the meter before attaching/detaching the sensor.
- If the meter is turned ON with the sensor detached, the battery alarm may light up. In this case, turn OFF the meter and attach the sensor, and then turn ON the meter again.

Attaching the sensor

1. Confirm that the waterproofing gasket is clean and undamaged.
2. Slide the sensor onto the meter so that catch "A" on the back of the meter fits into hole "a" on the sensor tongue as shown.

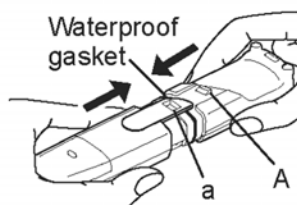

Note

Be careful not to twist the waterproof gasket.

Detaching the sensor

1. Lift the sensor tongue tip and slide the sensor a little away from the meter.
2. Pull out the sensor all the way from the meter.

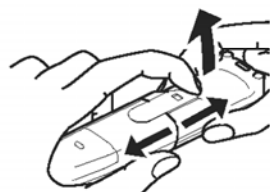

Note

- Make sure that the sensor tongue is outside the meter case. If the tongue is inserted between the case and the connector of the meter, it may damage the connector.

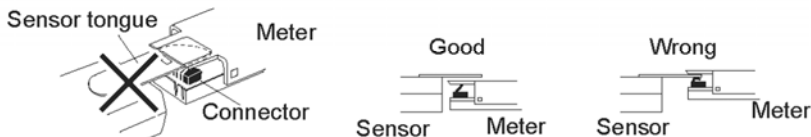

- When removing the sensor, do not let any water get inside the meter. If some moisture remains on the waterproof gasket, wipe it off carefully.

4.3 Power ON/OFF

■ Power ON

1. Press and hold the ON/OFF switch for over 2 seconds.

The power is turned ON, and the meter model number is displayed on the LCD.

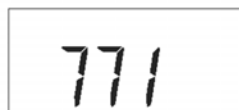
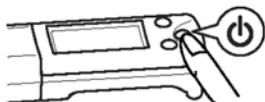

■ Power OFF

1. Press and hold the ON/OFF switch for over 2 seconds.

The power is turned OFF.

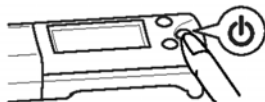

4.4 Storage

1. Clean the sensor with tap water and remove moisture on the sensor and meter with soft cloth or paper.
2. Close the protection cover, then store the meter.

4.5 Electrode surface treatment

Note

Before using the sensor for the first time, perform electrode surface treatment.

1. Put some drops of the moistening solution into the measurement cell.
2. Let it sit still for approximately 10 minutes.
3. Clean the measurement cell with running water.
4. Wash the measurement cell with the standard solution.
5. Perform calibration.

5 Calibration

5.1 About calibration

■ Calibration points

The following 2-type calibrations are available.

- One-point calibration: calibration at 1.41 mS/cm
- Two-point calibration: calibration at 1.41 mS/cm and 12.9 mS/cm (sold separately)

“One-point calibration” is set by default.

Refer to the instructions on page 18 for switching the calibration points.

The calibration point setting and calibration result are saved after the meter is turned OFF.

■ Precautions for calibration

- When using the sensor for the first time or again after several weeks of disuse, perform electrode surface treatment, as instructed on page 8, before calibration.
- Put an appropriate amount of the standard solution or a sample into the measurement cell without bubbles inside. If not, the measurement may be inaccurate.

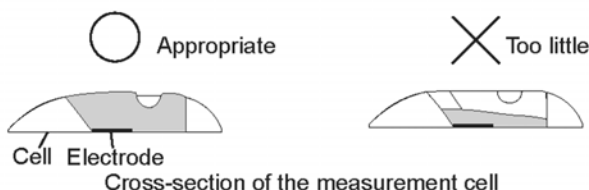

- If **CAL** remains blinking and Err (error display) appears, the calibration is failed. Check that the standard solution conductivity is correct, and perform calibration again after cleaning the sensor well.
- If the calibration is failed using correct standard solution(s), the sensor may be deteriorated. Replace the sensor with new one (part No.: 3200459672).
- In two-point calibration, confirm that the calibration operations are completed respectively for 1.41 mS/cm and 12.9 mS/cm. The calibration operation at 12.9 mS/cm can not start until the calibration at 1.41 mS/cm is completed, and the whole calibration sequence is not completed until the calibration at 12.9 mS/cm.

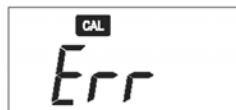

5.2 One-point calibration

1. Set “One-point calibration” (refer to page 18).
2. Open the protection cover and put some drops of the 1.41 mS/cm standard solution into the measurement cell.

Washing the sensor with the standard solution beforehand may provide more accurate calibration.

3. Close the protection cover and press the CAL switch for over 2 seconds.

CAL and ☺ blink and the calibration value is displayed.

After the calibration is completed, **CAL** and ☺ stop blinking and light steadily.

4. Clean the sensor with tap water and remove moisture.
5. Press the MEAS switch for 0.5 seconds to enter the measurement mode and prepare for measurement.

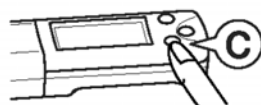

5.3 Two-point calibration

1. Set “Two-point calibration” (refer to page 18).
2. Open the protection cover and put some drops of the 1.41 mS/cm standard solution into the measurement cell.

Washing the sensor with the standard solution beforehand may provide more accurate calibration.

3. Close the protection cover and press the CAL switch for over 2 seconds.

CAL and ☺ blink and the calibration value is displayed.

After the calibration is completed, **CAL** and ☺ stop blinking and light steadily.

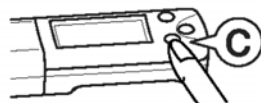

4. After the calibration for 1.41 mS/cm is completed, open the protection cover and remove the 1.41 mS/cm standard solution, and remove moisture.

5. Put some drops of the 12.9 mS/cm standard solution (sold separately) into the measurement cell.

Washing the sensor with the standard solution beforehand may provide more accurate calibration.

6. Close the protection cover and press the CAL switch for over 2 seconds.

CAL and ☺ blink and the calibration value is displayed.

After the calibration is completed, **CAL** and ☺ stop blinking and light steadily.

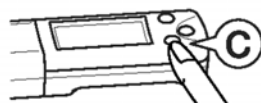

7. Clean the sensor with tap water and remove moisture.
8. Press the MEAS switch for 0.5 seconds to enter the measurement mode and prepare for measurement.

6 Measurement

6.1 Sample setting

The following 3-type sampling setting methods are available.

- Drop: for a small-amount sample
- Immersion: for a large-amount sample
- Scooping: for sampling a part of a sample

Note

- Although this product is waterproof, avoid immersing it completely. If the product is accidentally dropped into water, take it out of water and remove the moisture on it.
- Put an appropriate amount of the standard solution or a sample into the measurement cell without bubbles inside. If not, the measurement may be inaccurate.

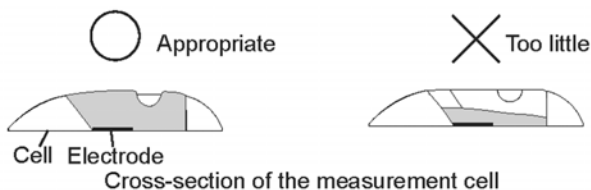

Drop

1. Open the protection cover.
2. Put some drops of sample into the measurement cell.



■ Immersion

1. Open the protection cover.
2. Immerse the sensor into the sample and stir gently 2 or 3 times.

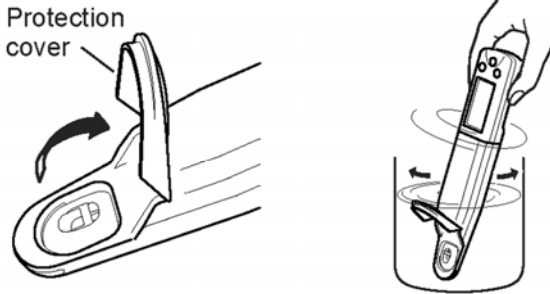

■ Scooping

1. Open the protection cover.
2. Immerse the sensor into the sample and stir gently 2 or 3 times, and then scoop up some of the sample with the sensor.
3. Place the meter flat and confirm that the sample is in the measurement cell.

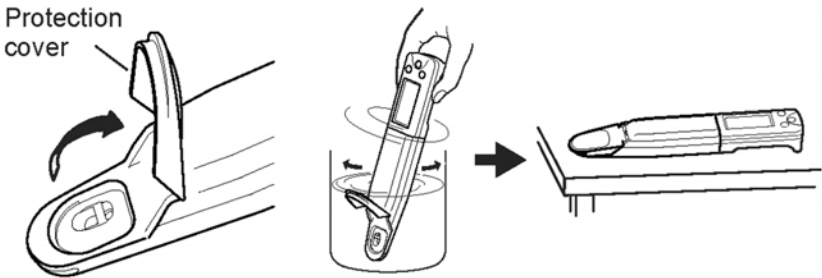

6.2 Measurement operations

■ Without using the reading locking function

1. Confirm that the meter is in the measurement mode, and set a sample on the sensor.
2. Read the displayed value when 😊 appears.



■ With using the reading locking function

1. Confirm that the meter is in the measurement mode, and set a sample on the sensor.
2. After 😊 appears, press the MEAS switch for 0.5 seconds.

The reading locking function is activated.

MEAS blinks until the measured value is stabilized.

When the measured value is settled, MEAS stops blinking and the displayed value is locked with MEAS and 😊 lighting steadily.



3. Read the displayed value.
4. Press the MEAS switch for 0.5 seconds.

The reading locking function is deactivated and MEAS disappears.

Note

- If a measurement result is out of the specified measurement range, the displayed measured value blinks.
 - Ambient air may cause the measured values to fluctuate. To reduce environment interference, close the protection cover.
 - When using the reading locking function, deactivate the function before starting every measurement.
-

7 Special Setting Mode

The special setting mode enables the meter setting and special operations. To enter the special setting mode, press and hold the MEAS switch for over 3 seconds in the measurement mode. All the LCD items appear, then the meter enters the special setting mode.

Tip

To exit the special setting mode with no setting change, press the ON/OFF switch to turn OFF and ON again.



All items appear.

* Pressing the CAL switch continuously switches the display in turn.

↓ Automatically



MEAS switch →

"7.1 Measurement unit setting" (page 16)
Used to select measurement unit.

↓ CAL switch*



MEAS switch →

"7.2 Temperature display mode" (page 17)
Displays the ambient temperature measured using an internal temperature sensor.

↓ CAL switch*

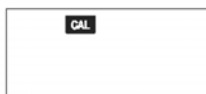

MEAS switch →

"7.3 Calibration point setting" (page 18)
Used to select the calibration points.

↓ CAL switch*

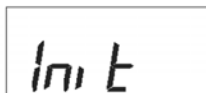

MEAS switch →

"7.4 Initialization mode" (page 19)
All settings and calibration data are reset to the factory default values.

↓ CAL switch*



"7.5 Software version display mode" (page 19)
The current software version is displayed.

↓ CAL switch*

Returns to the display for measurement unit setting.

7.1 Measurement unit setting

Used to select measurement unit.

1. **Press and hold the MEAS switch for over 3 seconds in the measurement mode to enter the special setting mode.**

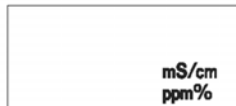

All items appear on the LCD, and then the display changes as shown above.

2. **Press the MEAS switch for 0.5 seconds.**
The current setting is displayed.
3. **Press the CAL switch for 0.5 seconds to change the setting.**
Pressing the CAL switch continuously switches the display in turn.

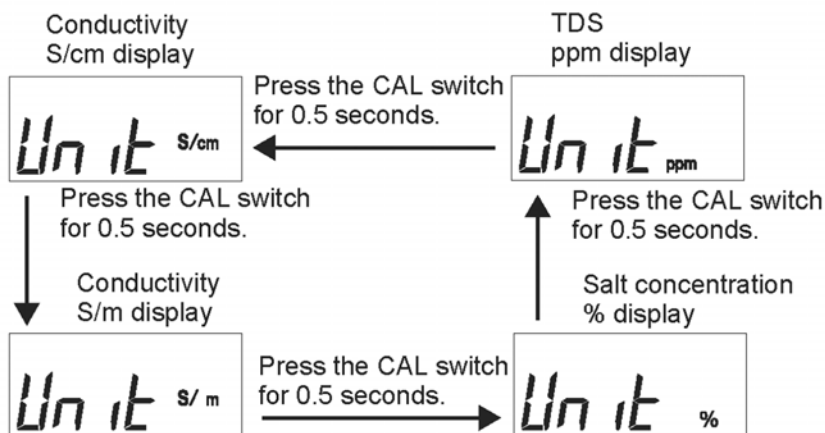

4. **Press the MEAS switch to apply the setting.**
The measurement mode is returned.

7.2 Temperature display mode

Displays the ambient temperature measured with the internal temperature sensor. The measurement accuracy is unwarranted. Use the value only as a guide.

- 1. Press and hold the MEAS switch for over 3 seconds in the measurement mode to enter the special setting mode.**

All items appear on the LCD, and then the display changes as shown right.



- 2. Press the CAL switch until °C appears.**



- 3. Press the MEAS switch for 0.5 seconds.**

The ambient temperature measured using an internal temperature sensor is displayed.



- 4. Press the MEAS switch to return the measurement mode.**

7.3 Calibration point setting

Used to select the calibration points.

1. **Press and hold the MEAS switch for over 3 seconds in the measurement mode to enter the special setting mode.**

All items appear on the LCD, and then the display changes as shown right.



2. **Press the CAL switch until CAL appears.**



3. **Press the MEAS switch for 0.5 seconds.**

The current setting is displayed.

4. **Press the CAL switch for 0.5 seconds to change the setting.**

One-point calibration



Press the CAL switch for 0.5 seconds.



Two-point calibration



5. **Press the MEAS switch to apply the setting.**

The measurement mode is returned.

7.4 Initialization mode

All settings and all calibration data are reset to the factory default values.

1. Press and hold the MEAS switch for over 3 seconds in the measurement mode to enter the special setting mode.

All items appear on the LCD, and then the display changes as shown right.



2. Press the CAL switch until Init appears.

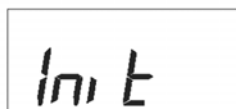

3. Press the MEAS switch for 0.5 seconds.

☺ appears.

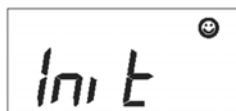

4. Press the CAL switch for over 2 seconds.

All settings and all calibration data are reset to the factory default values.

When initialization is completed, End and ☺ appear.



5. Press the ON/OFF switch to turn OFF and ON again.

7.5 Software version display mode

The current software version is displayed.

This information may be asked for depending on your inquiry.

1. Press and hold the MEAS switch for over 3 seconds in the measurement mode to enter the special setting mode.

All items appear on the LCD, and then the display changes as shown right.



2. Press the CAL switch until Init appears.

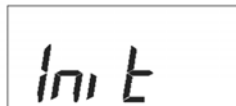

3. Press the CAL switch for 0.5 seconds.

The software version is displayed.



8 Appendix

8.1 Frequently asked questions

| Question | Answer |
|--|--|
| How long is the sensor's service life? | It depends on measurement samples and conditions. It should be approx. 1500 measurements for typical samples. Note that sensor deterioration and failure are not included in the warranty. |
| How can I check the sensor's condition? | Measure the provided standard solution to check how much the measured conductivity value drifts from the specified conductivity. If the measured value drifts, perform calibration. |
| What shall I do if calibration is failed? | Dirt in the measurement cell and electrode is the main cause of calibration failure. Perform electrode surface treatment (refer to page 8). If calibration is still failed after this, replace the sensor. |
| Are there any helpful tips or precautions to be aware for measurement? | Ambient air may cause the measured values to fluctuate. To reduce environment interference, close the protection cover. |
| | When the sample amount is enough, washing the sensor twice or so with the sample allows more accurate measurement. |
| | Residue between the protection cover and flat sensor prevents accurate measurement. Before measurement of the next sample, clean the sensor with tap water and remove moisture. |
| Can I measure high- or low-temperature samples? | This product can not measure a sample with a temperature outside the meter's operating temperature range (5°C to 40°C). The difference between the sample temperature and ambient temperature increases the measurement error. Perform measurement after the sample reaches the ambient temperature. |
| Can I prepare the moistening solution myself? | You can prepare the moistening solution by mixing neutral detergent with 20 times to 100 times as much water. |
| The measured value does not change after changing the sample. | If MEAS lights steadily, the measured value is locked. Press the MEAS switch to unlock the value. If the value does not change after unlocking, the sensor may be damaged. Replace the sensor. |
| The temperature alarm icon blinks during measurement. | The measuring environment temperature may not meet the specified operating temperature (5°C to 40°C). When the environment temperature is within the specified range and the alarm icon blinks, replace the sensor. |

| Question | Answer |
|--|--|
| The power is not turned ON. | Check that the batteries are inserted properly. If the batteries are low, replace them both with new ones at the same time. |
| Er1 is displayed right after power ON. | The internal IC in the meter may defect. After Er1 is displayed, the meter enters the initialization mode automatically and Init and ☺ appear. Press the CAL switch for over 2 seconds to execute initialization, and then turn OFF and ON again (refer to page 19). If Er1 is still displayed after the initialization, the internal IC in the meter defects. Replace the product with new one (the meter can not be repaired). |
| Er2 is displayed right after power ON. | The internal IC in the meter defects. Replace the product with new one (the meter can not be repaired). |
| Er3 is displayed right after power ON. | The internal IC in the meter defects. Replace the product with new one (the meter can not be repaired). |
| How can I return all the settings of the special setting mode to the default settings? | Perform initialization (refer to page 19). |

WARRANTY

This product is warranted to be free from defects in material or workmanship for one year from the date of purchase. During the warranty period Spectrum will, at its option, either repair or replace products that prove to be defective. This warranty does not cover damage due to improper installation or use, lightning, negligence, accident, or unauthorized modifications, or to incidental or consequential damages beyond the Spectrum product. Before returning a failed unit, you must obtain a Returned Materials Authorization (RMA) from Spectrum. Spectrum is not responsible for any package that is returned without a valid RMA number or for the loss of the package by any shipping company.



The Manufacturer's **DECLARATION OF CONFORMITY** certifies conformity to the following:

| | |
|---------------|---|
| Model Number: | 2205L |
| Description: | LAQUA Twin EC Meter |
| Type: | Portable Test and Measurement Equipment |
| Directive: | 2004/108/EC |
| Standards: | EN 61326-1 (2006), Class B |

Spectrum[®]
Technologies, Inc.

3600 Thayer Court
Aurora, IL 60504
(800) 248-8873 or (815) 436-4440
FAX: (815) 436-4460
E-Mail: info@specmeters.com
www.specmeters.com