

# POROUS

# CERAMICS

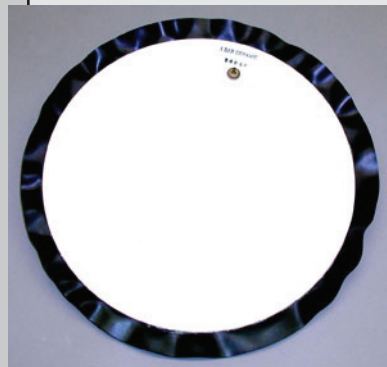
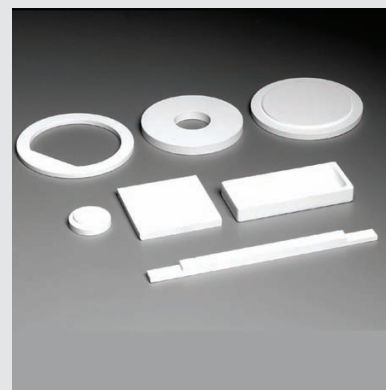

You will find some of the world's best porous ceramics in numerous shapes and sizes within this section. Soilmoisture manufactures the widest choice of air entry values and flow characteristics combined with a large selection of material types. Each porous ceramic part is produced with the utmost attention paid to detail and quality. These careful production procedures assure consistently close, uniform tolerances from purchase to purchase.

Perhaps your interests peak at incorporating a porous ceramic plate to filter or interface with a slurry or soil or finding a porous cup housing for a sensor. In any case, Soilmoisture most likely has a standard porous product to match your needs. For those with interests and needs a bit more unusual, let us provide you with a reasonable quote for a special ceramic in a size and shape that will specifically meet your needs.



SOILMOISTURE EQUIPMENT CORP.  
P.O. 30025, Santa Barbara, CA 93130  
Ofc: 801 S. Kellogg Ave., Goleta, CA. 93117  
<http://www.soilmoisture.com>  
PH: 1-805-964-3525 FAX 1-805-683-2189  
Contact: [sales@soilmoisture.com](mailto:sales@soilmoisture.com)



## CHOOSING A POROUS MATERIAL ADVANTAGES OF SOILMOISTURE PRECISION POROUS CERAMICS

### Porous Plastic sheet and stock

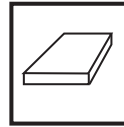
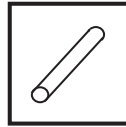

These materials, generally available in small rod or sheet form, are fabricated from one of several plastic materials. The most common are products formed by beads of Polyethylene or Polypropylene joined together or, in other cases, an expanded Teflon product. Generally the pores created are rather large, having discontinuities and bubbling pressures in the 1-5 psi range. To achieve a wetted surface takes special etchants to chemically etch the surface (usually hydrofluoric acids) and surface additives to achieve a reasonable capillary capacity. The life of these artificial hydrophilic coatings can substantially vary with use and are not generally guaranteed for extended use. Newer PVC extrusions or injected products that employ naturally porous additives result in a product with a wettable surface but rather moderate flow rates and, again, limited selection of low bubbling pressures. One might question these types of materials in any long term applications or projects requiring pressures or extraction differentials exceeding 5 psi, where the capillarity and flow characteristics must remain constant.

### Porous Plastic Films



Special porous films can be purchased in a wide range of thicknesses and pore sizes. Some are naturally wettable, while others require special coatings to assure wet ability. The films themselves are, unfortunately, quite flimsy and almost always require supportive backing materials and mechanical support to assure stability. The thinness of these materials also leaves them vulnerable to tearing and scratching. In the lab these film materials and devices work well in the filtering of solutions. Applying this technology, however, to in-situ work associated with soils, agricultural, and earth sciences applications would cause one to question their practicality. For instance, real hazards exist at the time of installation into soils for tearing, scratching, or pitting of the thin films or subsequent adequate and uniform surface by a contact highly flexible film. Then there are the other long term problems of loss or disassociation of the backing materials and supporting structures from the films that cause significant concerns.

### Porous Metals

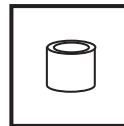
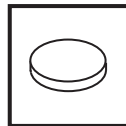

Generally found in disk form and occasionally in tubes, porous metals are comprised of small particles (soot size) pressed under high pressures and temperatures into a finished product. Most porous metal products are naturally wettable having a high ratio of pores, some of very large size. The result is that the products often have small amounts of leakage at bubbling pressures under 3 psi making them unsuitable for high pressures or extended extraction work. If the porous metals are fabricated from ferric metals, the product will quickly oxidize, "rusting" closed all possible pore pathways.

SOILMOISTURE EQUIPMENT CORP.  
P.O. 30025, Santa Barbara, CA 93130  
Ofc: 801 S. Kellogg Ave., Goleta, CA. 93117  
<http://www.soilmoisture.com>  
PH: 1-805-964-3525 FAX 1-805-683-2189  
Contact: [sales@soilmoisture.com](mailto:sales@soilmoisture.com)

# POROUS

# CERAMICS

## Precision Porous Ceramics

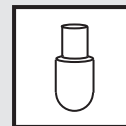
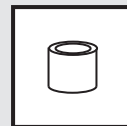
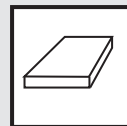
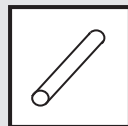
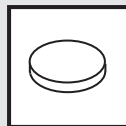

Unlike porous materials developed from plastics that are hydrophobic (water hating), ceramics are naturally wettable and hydrophilic (water loving). The tough durable nature of a fired porous ceramic makes it the preferential material of choice in the field of in-situ measurements, sampling or processing. Unlike porous metals that may oxidize or leak, porous ceramics are generally inert and can be produced with very consistent and uniform pore structures. Structures and devices fabricated from thick-walled porous ceramics can take the punishment of mechanical installation. With a wide selection of pore sizes, our precision porous ceramics can meet the most demanding pressure differential or suction values without leaks. The porous ceramic products we have available today have been proven for more than 40 years in all types of real world use. Each ceramic production batch and many individual ceramic products are individually tested for hydraulic properties and bubbling pressures. Our specialized knowledge of ceramics, glazing, assembly, or slip casting techniques allow us to meet your needs with creativity and value.

## UNDERSTANDING POROUS CERAMICS

**POROUS MATERIALS** : Materials containing a passage or channel, a small opening for absorbing or discharging fluids.

### The Closed Pore Structures

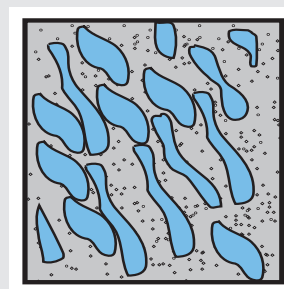
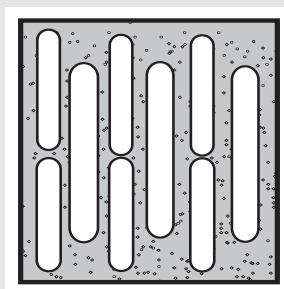

As the name would imply, this is a material in which the pathways or channels are blocked and do not provide the fluid a continuous and interconnected network of channels to connect one surface of the material to an opposing surface.

### The Open Pore Structures

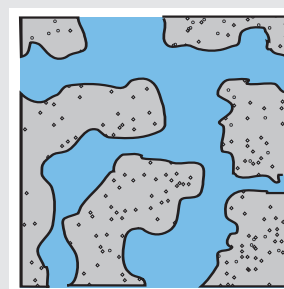
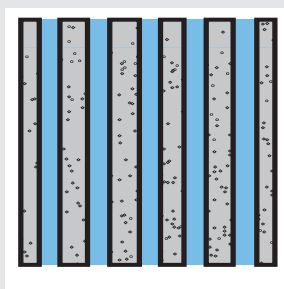

An open pore structure denotes a material that permits a fluid to move from one surface to an opposing surface in the material through a convoluted pathway of interconnecting networked channels. Soilmoisture ceramics are an example of an open pore structured material.



SOILMOISTURE EQUIPMENT CORP.  
P.O. 30025, Santa Barbara, CA 93130  
Ofc: 801 S. Kellogg Ave., Goleta, CA. 93117  
<http://www.soilmoisture.com>  
PH: 1-805-964-3525 FAX 1-805-683-2189  
Contact: [sales@soilmoisture.com](mailto:sales@soilmoisture.com)



## Hydrophobic Material - Water repelling

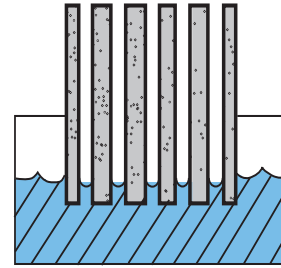

This term refers to materials such as porous plastics that have no affinity to wetting by water. These substances may have pores and channels but have no surface ability to wick water into the pores by the action of capillarity. Such materials are generally made from long chain organic molecules which have no substantial surface charges. Without a charged surface, there is no attractive or bonding effects on the polar molecules of water, and such substances must be specially treated.

## Hydrophilic Material- Water accepting

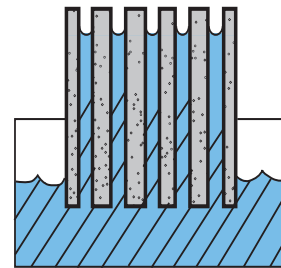

This term refers to those materials, such as porous ceramics and metals, that have a natural ability to fill pores by capillary action. This means the pores and channels of a ceramic have a highly charged pore surface that attracts and bonds the polar molecules of water and other polar fluids. The net effect is called “wicking” --- the ability to pull fluids into the material and transport that fluid by capillary forces. Soilmoisture ceramics are all hydrophilic.

## Pore Size

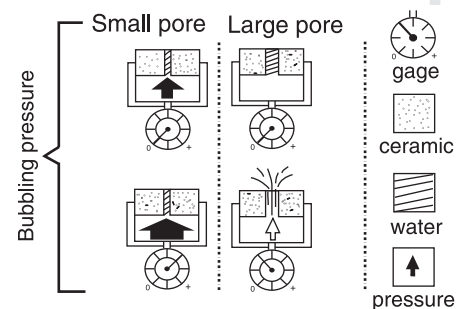
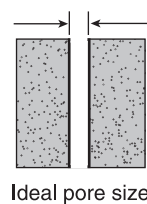

The pore size of a porous ceramic is of critical importance because it directly affects the ceramic’s air entry value or “bubbling pressure” and hydraulic conductivity. The air entry value is the pressure at which air will break through a wetted pore channel. The hydraulic (liquid) conductivity of a porous ceramic is a measure of the rate at which a ceramic material of known thickness may conduct liquid from one surface to an opposing surface under a known pressure. The hydraulic conductivity will vary with the type of pore fluid used which is generally water, but can be oils or other natural and artificial liquids. The effective pore size is determined by the minimum orifice within a channel or pore. These properties that are determined by pore size are intrinsic to ceramics and to all other porous materials. How a porous material behaves in any application is directly related to these pore properties and the material from which it is made. Soilmoisture assures consistent pore sizing by testing each batch and many individual porous products. See Table #1 that describes these properties.

# POROUS

# CERAMICS

Table 1. Physical properties of porous ceramics

AIR ENTRY VALUE	BUBBLING PRESSURE (PSI)	APPROXIMATE POROSITY (% vol.)	SATURATED HYDRAULIC CONDUCTIVITY (cm/sec)	MAXIMUM PORE SIZE (µm)	FLOW THROUGH 1/4-INCH PLATE (ml/hr/cm <sup>2</sup> /14.7 psi)
0.5 BAR (-B0.5M2)* HIGH FLOW	7 TO 9	50%	3.11 x 10 <sup>-5</sup>	6.0	180
1BAR (-B01M3)* HIGH FLOW	19 to 28	45%	8.6 x 10 <sup>-6</sup>	2.5	50
1 BAR (-B01M1)* STANDARD FLOW	20 to 30	34%	7.56 x 10 <sup>-7</sup>	1.7	5.0
2 BAR (-B02M1)* STANDARD FLOW	38 to 45	32%	6.30 x 10 <sup>-7</sup>	1.1	4.2
2 BAR (-B02M2)* HIGH FLOW	32 to 42	38%	6.93 x 10 <sup>-7</sup>	1.3	4.6
3 BAR (-B03M1)* STANDARD FLOW	46 to 70	34%	2.5 x 10 <sup>-7</sup>	0.7	1.6
5 BAR (-B05M1)* STANDARD FLOW	80	31%	1.21 x 10 <sup>-7</sup>	0.5	0.7
15 BAR (-B15M1)* STANDARD FLOW	220	32%	2.59 X 10 <sup>-9</sup>	0.16	0.015

\*Part number suffix corresponding to the appropriate air entry value and mix number. See addendum page for more details.



SOILMOISTURE EQUIPMENT CORP.  
P.O. 30025, Santa Barbara, CA 93130  
Ofc:801 S. Kellogg Ave., Goleta, CA. 93117  
http://www.soilmoisture.com  
PH: 1-805-964-3525 FAX 1-805-683-2189  
Contact: sales@soilmoisture.com



## POROUS CERAMICS APPLICATIONS AND USES

### Column work

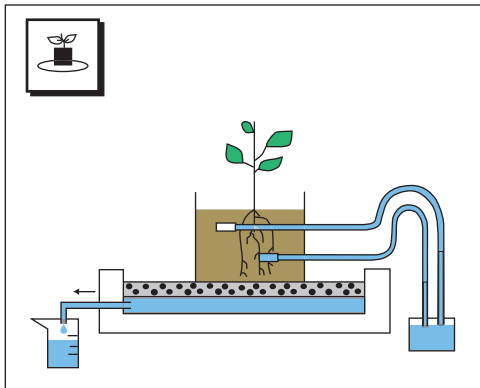

Laboratory soil columns or boxes are easily constructed and are a common way to simulate complex field conditions of interest. It's an easy way to monitor and see what's happening in real time. Whether the problem is field drainage, creating the proper matrix suction values for growth, or measuring changes in hydraulic potentials, Soilmoisture's porous ceramic products can help provide the answers.

### MOISTURE RETENTION CURVES

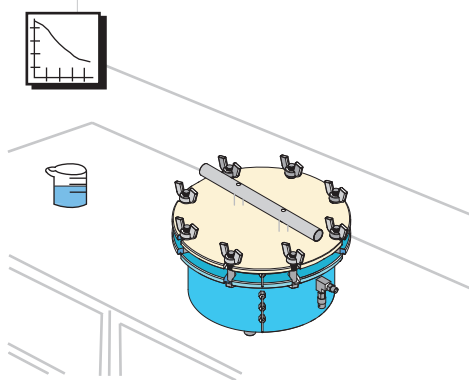

A basic of any soils study is the relationship between its water holding capability and the release of any held water. The universally recognized method for gaining this vital information is by using Soilmoisture Pressure Extractors, soil samples, and our porous ceramic plate or cup assemblies. The result of such testing, commonly known as a "moisture retention curve", is the relationship between volumetric or gravimetric water content and the extraction pressures necessary for a plant to remove that water. Soilmoisture has both the extractors and porous ceramic products you will need to run your own moisture retention curves.

### SOLUTION EXTRACTION OR TENSION MEASUREMENTS

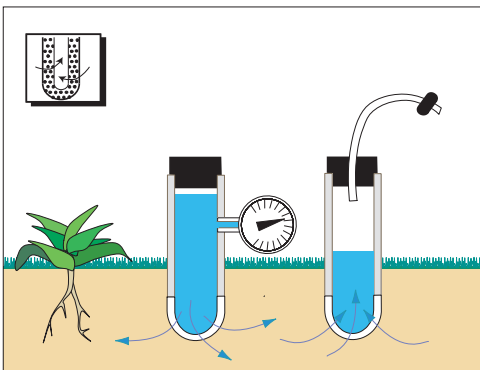

Simply attaching a porous ceramic cup to the end of a piece of connecting tubing and sealing the end makes a simple device that will provide significant scientific information. If a vacuum measuring device is tied into the connecting tube while water is withdrawn through the porous cup, water tension is measured (a tensiometer). On the other hand, if a vacuum is induced within a closed connecting tube, it is now possible to pull in water from the surrounding soil or material (a suction lysimeter or "soil water sampler").

SOILMOISTURE EQUIPMENT CORP.  
P.O. 30025, Santa Barbara, CA 93130  
Ofc: 801 S. Kellogg Ave., Goleta, CA. 93117  
<http://www.soilmoisture.com>  
PH: 1-805-964-3525 FAX 1-805-683-2189  
Contact: [sales@soilmoisture.com](mailto:sales@soilmoisture.com)

# POROUS

# CERAMICS

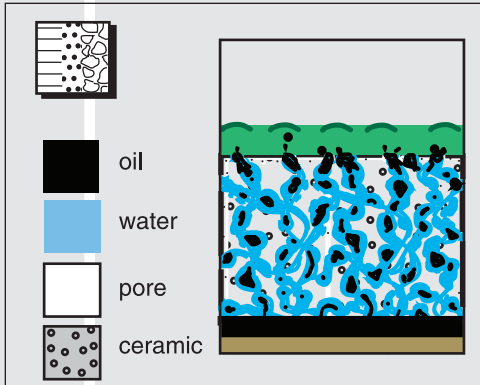

## PORE WATER INTERFACE

The unique characteristics of a wetted (pores filled with water) porous ceramic is its ability to join with wetted surfaces of materials nearby, therein creating a pore/water interface. With a wide variety of pore sizes, air entry values, shapes and sizes you are able to interface and measure hydraulic conductivity and flow rate properties without impedance from ceramic materials that are too fine or coarse for your work. The ability to monitor the interactive effects of water and 2 or 3 party systems having one or more immiscible liquids such as oils, etc., and their effects within natural pore structures are of great interest to oil and gas industries.

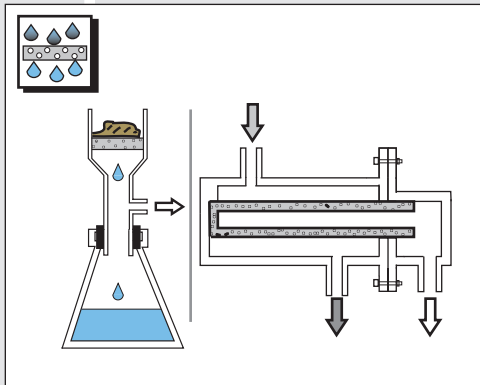

## FILTERS/DRAINS

Porous ceramics are a natural for a wide variety of filtering applications using liquids and pastes. Porous ceramics provide the tough and rigid capability suited to those filtering requirements that will not work with softer pliable paper or membrane filters. Because of their naturally hydrophilic surfaces, variety of fine pores sizes, and ability to be used under pressure or suction conditions, they assure that only the liquid portion of any phase mixture comes through.

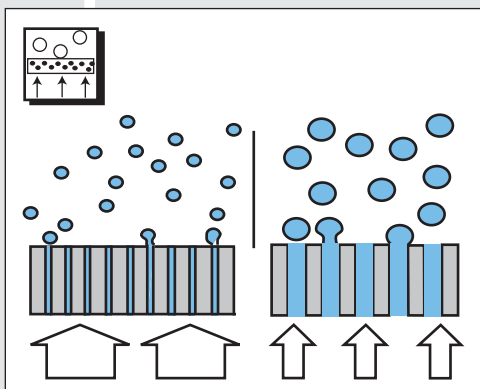

## AERATORS

The infusion of gases into liquids and pastes are important to process industries. Control of the size and volume of those bubbles is very important and Soilmoisture's porous ceramics provide a rich selection of aeration materials. Whether it's air sparging to accelerate bacterial digestion deep in underground remediation wells or the foaming of a liquid in an infusion process, there is probably a porous ceramic to fit the need.



SOILMOISTURE EQUIPMENT CORP.  
P.O. 30025, Santa Barbara, CA 93130  
Ofc: 801 S. Kellogg Ave., Goleta, CA. 93117  
<http://www.soilmoisture.com>  
PH: 1-805-964-3525 FAX 1-805-683-2189  
Contact: [sales@soilmoisture.com](mailto:sales@soilmoisture.com)



## POROUS CERAMICS 0600 TO 0699

- Hundreds of stock items in various formats
- A wide selection of tough rugged shapes and sizes
- Naturally wetting pores of very uniform sizes
- Standard tight tolerances or custom shapes with the precision you need
- Most can be modified by standard techniques
- Customs and Special available usually in 4 weeks.
- Glazing and machining to exacting standards.
- We'll create specialized assemblies to meet specific needs.

## FEATURES

The ceramic products offered in these sections are our most popular which have been sold for decades to discriminating customers like yourself who demand the very best. Each specialty area of our ceramics product line represents the finest quality products available to you as a consumer. Many of the items are used in the fabrication of our quality field and research laboratory equipment sold under the Soilmoisture name.

The unique characteristics and quality of our porous ceramics allow them to be used in a variety of applications. The natural wetting abilities of a porous ceramic, the uniform pore sizing, and inert raw materials provide an excellent finished product for research or industrial applications. Combine these attractive features with the strength and durability capabilities of a variety of ceramic shapes and you have a limitless number of excellent possibilities.

For your convenience, at the back of this ceramics section we have provided a compendium of accessories and materials that you might find helpful in completing your project. We are constantly adding new ceramic products, and we encourage you to consult our web site at <http://www.soilmoisture.com> in the ceramic section for these new additions. If you can't find the right product to meet your special porous ceramic needs, please send us a sketch including the tolerances and quantities required for a quick bid. For those O.E.M.s looking for large commercial quantities, Soilmoisture can provide your specialty item at substantial savings.

## TYPICAL APPLICATIONS



SOILMOISTURE EQUIPMENT CORP.  
P.O. 30025, Santa Barbara, CA 93130  
Ofc: 801 S. Kellogg Ave., Goleta, CA. 93117  
<http://www.soilmoisture.com>  
PH: 1-805-964-3525 FAX 1-805-683-2189  
Contact: [sales@soilmoisture.com](mailto:sales@soilmoisture.com)





# POROUS

# CERAMICS

## 0600 Ceramic Plates

Plates listed are "as cast". We can provide special plates to meet specific requirements. Soilmoisture's technical staff may be contacted for more information on placing special orders.

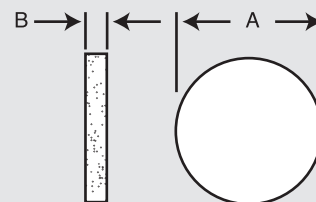

AIR ENTRY VALUE	DIMENSIONS/TOLERANCES						Part Number
	A		B		Weight		
	Inches	cm	Inches	cm	oz.	gms	
0.5 BAR HF	0.625 +0.063 -0.063	1.588 +0.160 -0.160	0.281 +0.031 -0.016	0.714 +0.079 -0.041	0.16	4.53	0604D0.5-B0.5M2
0.5 BAR HF	1.125 +0.063 -0.063	2.858 +0.160 -0.160	0.281 +0.031 -0.016	0.714 +0.079 -0.041	0.24	6.91	0604D01-B0.5M2
0.5 BAR HF	1.625 +0.063 -0.063	4.128 +0.160 -0.160	0.281 +0.031 -0.016	0.714 +0.079 -0.041	0.51	14.41	0604D01.5-B0.5M2
0.5 BAR HF	2.125 +0.063 -0.063	5.398 +0.160 -0.160	0.281 +0.031 -0.016	0.714 +0.079 -0.041	0.87	24.65	0604D02-B0.5M2
0.5 BAR HF	2.625 +0.063 -0.063	6.668 +0.160 -0.160	0.281 +0.031 -0.016	0.714 +0.079 -0.041	1.44	4.82	0604D02.5-B0.5M2
0.5 BAR HF	3.125 +0.063 -0.063	7.938 +0.160 -0.160	0.281 +0.031 -0.016	0.714 +0.079 -0.041	1.88	53.31	0604D03-B0.5M2
0.5 BAR HF	4.125 +0.063 -0.063	10.478 +0.160 -0.160	0.281 +0.031 -0.016	0.714 +0.079 -0.041	3.28	92.88	0604D04-B0.5M2
0.5 BAR HF	5.125 +0.063 -0.063	13.018 +0.160 -0.160	0.281 +0.031 -0.016	0.714 +0.079 -0.041	5.06	143.37	0604D05-B0.5M2
0.5 BAR HF	6.125 +0.090 -0.090	15.558 +0.229 -0.229	0.281 +0.031 -0.016	0.714 +0.079 -0.041	7.22	204.78	0604D06-B0.5M2
0.5 BAR HF	0.625 +0.063 -0.063	1.588 +0.160 -0.160	0.406 +0.031 -0.016	1.031 +0.079 -0.041	0.16	4.53	0606D0.5-B0.5M2
0.5 BAR HF	1.125 +0.063 -0.063	2.858 +0.160 -0.160	0.406 +0.031 -0.016	1.031 +0.079 -0.041	0.32	9.07	0606D01-B0.5M2
0.5 BAR HF	1.625 +0.063 -0.063	4.128 +0.160 -0.160	0.406 +0.031 -0.016	1.031 +0.079 -0.041	0.64	18.14	0606D01.5-B0.5M2
0.5 BAR HF	2.125 +0.063 -0.063	5.398 +0.160 -0.160	0.406 +0.031 -0.016	1.031 +0.079 -0.041	1.26	35.61	0606D02-B0.5M2
0.5 BAR HF	2.625 +0.063 -0.063	6.668 +0.160 -0.160	0.406 +0.031 -0.016	1.031 +0.079 -0.041	2.24	63.50	0606D02.5-B0.5M2



SOILMOISTURE EQUIPMENT CORP.  
P.O. 30025, Santa Barbara, CA 93130  
Ofc: 801 S. Kellogg Ave., Goleta, CA. 93117  
<http://www.soilmoisture.com>  
PH: 1-805-964-3525 FAX 1-805-683-2189  
Contact: [sales@soilmoisture.com](mailto:sales@soilmoisture.com)



## 0600 Ceramic Plates (Continued)

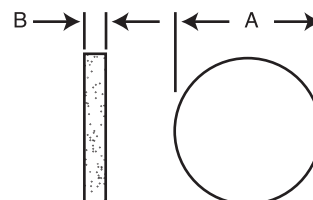

AIR ENTRY VALUE	DIMENSIONS/TOLERANCES						Part number
	A		B		Weight		
	Inches	cm	Inches	cm	oz.	gms	
0.5 BAR HF	3.125 +0.063 -0.063	7.938 +0.160 -0.160	0.406 +0.031 -0.016	1.031 +0.079 -0.041	2.72	77.02	0606D03-B0.5M2
0.5 BAR HF	4.125 +0.063 -0.063	1.478 +0.160 -0.160	0.406 +0.031 -0.016	1.031 +0.079 -0.041	4.73	134.20	0606D04-B0.5M2
0.5 BAR HF	5.125 +0.063 -0.063	13.018 +0.160 -0.160	0.406 +0.031 -0.016	1.031 +0.079 -0.041	7.31	207.15	0606D05-B0.5M2
0.5 BAR HF	10.875 +0.125 -0.125	27.623 +0.318 -0.318	0.406 +0.031 -0.031	1.031 +0.079 -0.079	32.90	932.72	0606D11-B0.5M2
1 BAR STD	0.625 +0.063 -0.063	1.588 +0.160 -0.160	0.281 +0.031 -0.016	0.714 +0.079 -0.041	0.09	2.52	0604D0.5-B01M1
1 BAR STD	0.625 +0.063 -0.063	1.588 +0.160 -0.160	0.406 +0.031 -0.016	1.031 +0.079 -0.041	0.13	3.64	0606D0.5-B01M1
1 BAR STD	1.125 +0.063 -0.063	2.858 +0.160 -0.160	0.281 +0.031 -0.016	0.714 +0.079 -0.041	0.29	8.17	0604D01-B01M1
1 BAR STD	1.125 +0.063 -0.063	2.858 +0.160 -0.160	0.406 +0.031 -0.016	1.031 +0.079 -0.041	0.42	11.80	0606D01-B01M1
1 BAR STD	1.625 +0.063 -0.063	4.128 +0.160 -0.160	0.281 +0.031 -0.016	0.714 +0.079 -0.041	0.60	17.05	0604D01.5-B01M1
1 BAR STD	1.625 +0.063 -0.063	4.128 +0.160 -0.160	0.406 +0.031 -0.016	1.031 +0.079 -0.041	0.87	24.62	0606D01.5-B01M1
1 BAR STD	2.125 +0.063 -0.063	5.398 +0.160 -0.160	0.281 +0.031 -0.016	0.714 +0.079 -0.041	1.03	29.14	0604D02-B01M1
1 BAR STD	2.125 +0.063 -0.063	5.398 +0.160 -0.160	0.406 +0.031 -0.016	1.031 +0.079 -0.041	1.48	42.10	0606D02-B01M1
1 BAR STD	2.625 +0.063 -0.063	6.668 +0.160 -0.160	0.281 +0.031 -0.016	0.714 +0.079 -0.041	1.57	44.46	0604D02.5-B01M1
1 BAR STD	2.625 +0.063 -0.063	6.668 +0.160 -0.160	0.406 +0.031 -0.016	1.031 +0.079 -0.041	2.27	64.24	0606D02.5-B01M1

SOILMOISTURE EQUIPMENT CORP.  
P.O. 30025, Santa Barbara, CA 93130  
Ofc: 801 S. Kellogg Ave., Goleta, CA. 93117  
<http://www.soilmoisture.com>  
PH: 1-805-964-3525 FAX 1-805-683-2189  
Contact: [sales@soilmoisture.com](mailto:sales@soilmoisture.com)



# POROUS

# CERAMICS

## 0600 Ceramic Plates (Continued)

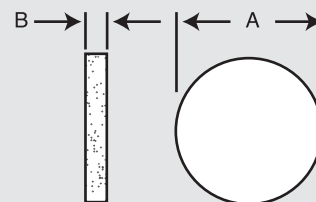

AIR ENTRY VALUE	DIMENSIONS/TOLERANCES						Part number
	A		B		Weight		
	Inches	cm	Inches	cm	oz.	gms	
1 BAR STD	3.125 +0.063 -0.063	7.938 +0.160 -0.160	0.281 +0.031 -0.016	0.714 +0.079 -0.041	2.22	63.01	0604D03-B01M1
1 BAR STD	3.125 +0.063 -0.063	7.938 +0.160 -0.160	0.406 +0.031 -0.016	1.031 +0.079 -0.041	3.21	81.04	0606D03-B01M1
1 BAR STD	4.125 +0.063 -0.063	1.478 +0.160 -0.160	0.281 +0.031 -0.016	0.714 +0.079 -0.041	3.87	92.88	0604D04-B01M1
1 BAR STD	4.125 +0.063 -0.063	1.478 +0.160 -0.160	0.406 +0.031 -0.016	1.031 +0.079 -0.041	4.73	134.20	0606D04-B01M1
1 BAR STD	5.125 +0.063 -0.063	13.018 +0.160 -0.160	.281 +0.031 -0.016	0.714 +0.079 -0.041	5.98	143.37	0604D05-B01M1
1 BAR STD	5.125 +0.063 -0.063	13.018 +0.160 -0.160	0.406 +0.031 -0.016	1.031 +0.079 -0.041	8.64	244.86	0606D05-B01M1
1 BAR STD	6.125 +0.090 -0.090	15.558 +0.160 -0.160	0.281 +0.031 -0.016	0.714 +0.079 -0.041	8.54	242.06	0604D06-B01M1
1 BAR STD	6.125 +0.090 -0.090	15.558 +0.229 -0.229	0.406 +0.031 -0.016	1.031 +0.079 -0.041	12.34	349.74	0606D06-B01M1
1 BAR STD	10.875 +0.125 -0.125	27.623 +0.318 -0.318	0.281 +0.031 -0.031	0.714 +0.079 -0.079	26.92	763.09	0604D11-B01M1
1 BAR STD	10.875 +0.125 -0.125	27.623 +0.318 -0.318	0.406 +0.031 -0.031	1.031 +0.079 -0.079	38.89	1102.54	0606D11-B01M1
1 BAR HF	0.625 +0.063 -0.063	1.588 +0.160 -0.160	0.281 +0.031 -0.016	0.714 +0.079 -0.041	0.10	2.72	0604D0.5-B01M3
1 BAR HF	0.625 +0.063 -0.063	1.588 +0.160 -0.160	0.406 +0.031 -0.016	1.031 +0.079 -0.041	0.14	3.84	0606D0.5-B01M3
1 BAR HF	1.125 +0.063 -0.063	2.858 +0.160 -0.160	0.281 +0.031 -0.016	0.714 +0.079 -0.041	0.31	8.83	0604D01-B01M3
1 BAR HF	1.125 +0.063 -0.063	2.858 +0.160 -0.160	0.406 +0.031 -0.016	1.031 +0.079 -0.041	0.45	12.75	0606D01-B01M3



SOILMOISTURE EQUIPMENT CORP.  
P.O. 30025, Santa Barbara, CA 93130  
Ofc: 801 S. Kellogg Ave., Goleta, CA. 93117  
<http://www.soilmoisture.com>  
PH: 1-805-964-3525 FAX 1-805-683-2189  
Contact: [sales@soilmoisture.com](mailto:sales@soilmoisture.com)



## 0600 Ceramic Plates (Continued)

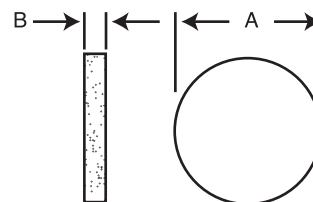

AIR ENTRY VALUE	DIMENSIONS/TOLERANCES						Part number
	A		B		Weight		
	Inches	cm	Inches	cm	oz.	gms	
1 BAR HF	1.625 +0.063 -0.063	4.128 +0.160 -0.160	0.281 +0.031 -0.016	0.714 +0.079 -0.041	0.65	18.41	0604D01.5-B01M3
1 BAR HF	1.625 +0.063 -0.063	4.128 +0.160 -0.160	0.406 +0.031 -0.016	1.031 +0.079 -0.041	0.94	26.61	0606D01.5-B01M3
1 BAR HF	2.125 +0.063 -0.063	5.398 +0.160 -0.160	0.281 +0.031 -0.016	0.714 +0.079 -0.041	1.11	31.49	0604D02-B01M3
1 BAR HF	2.625 +0.063 -0.063	6.668 +0.160 -0.160	0.281 +0.031 -0.016	0.714 +0.079 -0.041	1.69	48.05	0604D02.5-B01M3
1 BAR HF	2.625 +0.063 -0.063	6.668 +0.160 -0.160	0.406 +0.031 -0.016	1.031 +0.079 -0.041	1.44	4.82	0606D02.5-B01M3
1 BAR HF	2.625 +0.063 -0.063	6.668 +0.160 -0.160	0.406 +0.031 -0.016	1.031 +0.079 -0.041	2.45	69.43	0606D02.5-B01M3
1 BAR HF	3.125 +0.063 -0.063	7.938 +0.160 -0.160	0.281 +0.031 -0.016	0.714 +0.079 -0.041	2.40	68.10	0604D03-B01M3
1 BAR HF	3.125 +0.063 -0.063	7.938 +0.160 -0.160	0.406 +0.031 -0.016	1.031 +0.079 -0.041	3.47	98.39	0606D03-B01M3
1 BAR HF	4.125 +0.063 -0.063	10.478 +0.160 -0.160	0.281 +0.031 -0.016	0.714 +0.079 -0.041	4.19	118.66	0604D04-B01M3
1 BAR HF	4.125 +0.063 -0.063	10.478 +0.160 -0.160	0.406 +0.031 -0.016	1.031 +0.079 -0.041	6.05	171.40	0606D04-B01M3
1 BAR HF	5.125 +0.063 -0.063	13.018 +0.160 -0.160	0.281 +0.031 -0.016	0.714 +0.079 -0.041	6.46	183.16	0604D05-B01M3
1 BAR HF	5.125 +0.063 -0.063	13.018 +0.160 -0.160	0.406 +0.031 -0.016	1.031 +0.079 -0.041	9.33	264.86	0606D05-B01M3
1 BAR HF	6.125 +0.063 -0.063	15.558 +0.160 -0.160	0.281 +0.031 -0.016	0.714 +0.079 -0.041	9.23	261.61	0604D06-B01M3
1 BAR HF	6.125 +0.063 -0.063	15.558 +0.160 -0.160	0.406 +0.031 -0.016	1.031 +0.079 -0.041	12.64	358.34	0606D06-B01M3

SOILMOISTURE EQUIPMENT CORP.  
P.O. 30025, Santa Barbara, CA 93130  
Ofc: 801 S. Kellogg Ave., Goleta, CA. 93117  
<http://www.soilmoisture.com>  
PH: 1-805-964-3525 FAX 1-805-683-2189  
Contact: [sales@soilmoisture.com](mailto:sales@soilmoisture.com)



# POROUS

# CERAMICS

## 0600 Ceramic Plates (Continued)

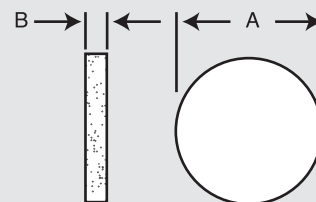

AIR ENTRY VALUE	DIMENSIONS/TOLERANCES						Part number
	A		B		Weight		
	Inches	cm	Inches	cm	oz.	gms	
1 BAR HF	10.875 +0.125 -0.125	27.623 +0.318 -0.318	0.406 +0.031 -0.031	1.031 +0.079 -0.079	13.4	379.88	0606D11-B01M3
2 BAR STD	4.125 +0.063 -0.063	10.478 +0.160 -0.160	0.281 +0.031 -0.016	0.714 +0.079 -0.041	3.62	102.50	0604D04-B02M1
2 BAR STD	5.125 +0.063 -0.063	13.018 +0.160 -0.160	0.281 +0.031 -0.016	0.714 +0.079 -0.041	5.58	158.23	0604D05-B02M1
2 BAR STD	1.875 +0.125 -0.125	27.623 +0.318 -0.318	0.281 +0.031 -0.031	0.714 +0.079 -0.079	25.13	712.45	0604D11-B02M1
3 BAR STD	0.625 +0.063 -0.063	1.588 +0.160 -0.160	0.281 +0.031 -0.016	0.714 +0.079 -0.041	0.09	2.35	0604D0.5-B03M1
3 BAR STD	0.625 +0.063 -0.063	1.588 +0.160 -0.160	0.406 +0.031 -0.016	1.031 +0.079 -0.041	0.12	3.54	0606D0.5-B03M1
3 BAR STD	1.125 +0.063 -0.063	2.858 +0.160 -0.160	0.281 +0.031 -0.016	0.714 +0.079 -0.041	0.28	7.93	0604D01-B03M1
3 BAR STD	1.125 +0.063 -0.063	2.858 +0.160 -0.160	0.406 +0.031 -0.016	1.031 +0.079 -0.041	0.40	11.46	0606D01-B03M1
3 BAR STD	1.625 +0.063 -0.063	4.128 +0.160 -0.160	0.281 +0.031 -0.016	0.714 +0.079 -0.041	0.58	16.55	0604D01.5-B03M1
3 BAR STD	1.625 +0.063 -0.063	4.128 +0.160 -0.160	0.406 +0.031 -0.016	1.031 +0.079 -0.041	0.84	23.91	0606D01.5-B03M1
3 BAR STD	2.125 +0.063 -0.063	5.398 +0.160 -0.160	0.281 +0.031 -0.016	0.714 +0.079 -0.041	1.00	28.30	0604D02-B03M1
3 BAR STD	2.125 +0.063 -0.063	5.398 +0.160 -0.160	0.406 +0.031 -0.016	1.031 +0.079 -0.041	1.44	4.89	0606D02-B03M1
3 BAR STD	2.625 +0.063 -0.063	6.668 +0.160 -0.160	0.281 +0.031 -0.016	0.714 +0.079 -0.041	1.52	43.19	0604D02.5-B03M1
3 BAR STD	2.625 +0.063 -0.063	6.668 +0.160 -0.160	0.406 +0.031 -0.016	1.031 +0.079 -0.041	2.20	62.40	0606D02.5-B03M1



SOILMOISTURE EQUIPMENT CORP.  
P.O. 30025, Santa Barbara, CA 93130  
Ofc: 801 S. Kellogg Ave., Goleta, CA. 93117  
<http://www.soilmoisture.com>  
PH: 1-805-964-3525 FAX 1-805-683-2189  
Contact: [sales@soilmoisture.com](mailto:sales@soilmoisture.com)



## 0600 Ceramic Plates (Continued)

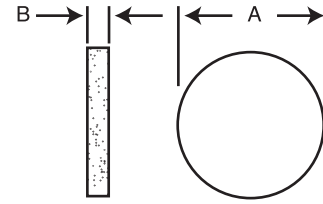

AIR ENTRY VALUE	DIMENSIONS/TOLERANCES						Part number
	A		B		Weight		
	Inches	cm	Inches	cm	oz.	gms	
3 BAR STD	3.125 +0.063 -0.063	7.938 +0.160 -0.160	0.281 +0.031 -0.016	0.714 +0.079 -0.041	8.65	61.20	0604D03-B03M1
3 BAR STD	3.125 +0.063 -0.063	7.938 +0.160 -0.160	0.406 +0.031 -0.016	1.031 +0.079 -0.041	3.12	88.44	0606D03-B03M1
3 BAR STD	4.125 +0.063 -0.063	10.478 +0.160 -0.160	0.281 +0.031 -0.016	0.714 +0.079 -0.041	3.76	106.65	0604D04-B03M1
3 BAR STD	4.125 +0.063 -0.063	10.478 +0.160 -0.160	0.406 +0.031 -0.016	1.031 +0.079 -0.041	5.44	154.10	0606D04-B03M1
3 BAR STD	5.125 +0.063 -0.063	13.018 +0.160 -0.160	0.281 +0.031 -0.016	0.714 +0.079 -0.041	5.81	164.63	0604D05-B03M1
3 BAR STD	5.125 +0.063 -0.063	13.018 +0.160 -0.160	0.406 +0.031 -0.016	1.031 +0.079 -0.041	8.39	237.86	0606D05-B03M1
3 BAR STD	6.125 +0.090 -0.090	15.558 +0.229 -0.229	0.281 +0.031 -0.016	0.714 +0.079 -0.041	8.29	235.14	0604D06-B03M1
3 BAR STD	6.125 +0.090 -0.090	15.558 +0.229 -0.229	0.406 +0.031 -0.016	1.031 +0.079 -0.041	11.98	339.75	0606D06-B03M1
3 BAR STD	10.875 +0.125 -0.125	27.623 +0.318 -0.318	0.281 +0.031 -0.031	0.714 +0.079 -0.079	26.15	741.28	0604D11-B03M1
5 BAR STD	0.625 +0.063 -0.063	1.588 +0.160 -0.160	0.281 +0.031 -0.016	0.714 +0.079 -0.041	0.09	2.45	0604D0.5-B05M1
5 BAR STD	0.625 +0.063 -0.063	1.588 +0.160 -0.160	0.406 +0.031 -0.016	1.031 +0.079 -0.041	0.12	3.54	0606D0.5-B05M1
5 BAR STD	1.125 +0.063 -0.063	2.858 +0.160 -0.160	0.281 +0.031 -0.016	0.714 +0.079 -0.041	0.28	7.94	0604D01-B05M1
5 BAR STD	1.125 +0.063 -0.063	2.858 +0.160 -0.160	0.406 +0.031 -0.016	1.031 +0.079 -0.041	0.40	11.47	0606D01-B05M1
5 BAR STD	1.625 +0.063 -0.063	4.128 +0.160 -0.160	0.281 +0.031 -0.016	0.714 +0.079 -0.041	0.58	16.57	0604D01.5-B05M1

SOILMOISTURE EQUIPMENT CORP.  
P.O. 30025, Santa Barbara, CA 93130  
Ofc: 801 S. Kellogg Ave., Goleta, CA. 93117  
<http://www.soilmoisture.com>  
PH: 1-805-964-3525 FAX 1-805-683-2189  
Contact: [sales@soilmoisture.com](mailto:sales@soilmoisture.com)



# POROUS

# CERAMICS

## 0600 Ceramic Plates (Continued)

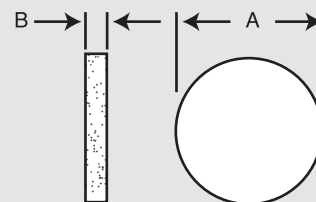

AIR ENTRY VALUE	DIMENSIONS/TOLERANCES						Part number
	A		B		Weight		
	Inches	cm	Inches	cm	oz.	gms	
5 BAR STD	1.625 +0.063 -0.063	4.128 +0.160 -0.160	0.406 +0.031 -0.016	1.031 +0.079 -0.041	0.84	23.94	0606D01.5-B05M1
5 BAR STD	2.125 +0.063 -0.063	5.398 +0.160 -0.160	0.281 +0.031 -0.016	0.714 +0.079 -0.041	1.00	28.33	0604D02-B05M1
5 BAR STD	2.125 +0.063 -0.063	5.398 +0.160 -0.160	0.406 +0.031 -0.016	1.031 +0.079 -0.041	1.44	4.93	0606D02-B05M1
5 BAR STD.	2.625 +0.063 -0.063	6.668 +0.160 -0.160	0.281 +0.031 -0.016	0.714 +0.079 -0.041	1.524	3.23	0604D02.5-B05M1
5 BAR STD.	2.625 +0.063 -0.063	6.668 +0.160 -0.160	0.406 +0.031 -0.016	1.031 +0.079 -0.041	2.20	62.46	0606D02.5-B05M1
5 BAR STD	3.125 +0.063 -0.063	7.938 +0.160 -0.160	0.281 +0.031 -0.031	0.714 +0.079 -0.041	2.16	61.27	0604D03-B05M1
5 BAR STD	3.125 +0.063 -0.063	7.938 +0.160 -0.160	0.406 +0.031 -0.016	1.031 +0.079 -0.041	3.12	88.53	0606D03-B05M1
5 BAR STD	4.125 +0.063 -0.063	10.478 +0.160 -0.160	0.281 +0.031 -0.016	0.714 +0.079 -0.041	3.77	106.76	0604D04-B05M1
5 BAR STD	4.125 +0.063 -0.063	10.478 +0.160 -0.160	0.406 +0.031 -0.016	1.031 +0.079 -0.041	5.44	154.25	0606D04-B05M1
5 BAR STD	5.125 +0.063 -0.063	13.018 +0.160 -0.160	0.281 +0.031 -0.016	0.714 +0.079 -0.041	5.81	164.79	0604D05-B05M1
5 BAR STD	5.125 +0.063 -0.063	13.018 +0.160 -0.229	0.406 +0.031 -0.016	1.031 +0.079 -0.041	8.40	238.10	0606D05-B05M1
5 BAR STD	6.125 +0.090 -0.090	15.558 +0.229 -0.229	0.281 +0.031 -0.016	0.714 +0.079 -0.041	8.30	235.37	0604D06-B05M1
5 BAR STD	6.125 +0.090 -0.090	15.558 +0.229 -0.229	0.406 +0.031 -0.016	1.031 +0.079 -0.041	12.00	34.08	0606D06-B05M1
15 BAR STD	0.625 +0.063 -0.063	1.588 +0.160 -0.160	0.281 +0.031 -0.016	0.714 +0.079 -0.041	0.16	4.53	0604D0.5-B15M1



SOILMOISTURE EQUIPMENT CORP.  
P.O. 30025, Santa Barbara, CA 93130  
Ofc: 801 S. Kellogg Ave., Goleta, CA. 93117  
<http://www.soilmoisture.com>  
PH: 1-805-964-3525 FAX 1-805-683-2189  
Contact: [sales@soilmoisture.com](mailto:sales@soilmoisture.com)



## 0600 Ceramic Plates (Continued)

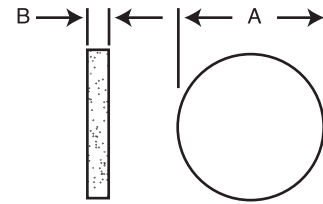

AIR ENTRY VALUE							Part number
	A		B		Weight		
	Inches	cm	Inches	cm	oz.	gms	
15 BAR STD	1.125 +0.063 -0.063	2.858 +0.160 -0.160	0.281 +0.031 -0.016	0.714 +0.079 -0.041	0.28	7.91	0604D01-B15M1
15 BAR STD	1.125 +0.063 -0.063	2.858 +0.160 -0.160	0.406 +0.031 -0.016	1.031 +0.079 -0.041	0.58	16.44	0606D01-B15M1
15 BAR STD	1.625 +0.063 -0.063	4.128 +0.160 -0.160	0.281 +0.031 -0.016	0.714 +0.079 -0.041	0.58	16.50	0604D01.5-B15M1
15 BAR STD	2.125 +0.063 -0.063	5.398 +0.160 -0.160	0.281 +0.031 -0.016	0.714 +0.079 -0.041	1.00	28.33	0604D02-B15M1
15 BAR STD	2.625 +0.063 -0.063	6.668 +0.160 -0.160	0.281 +0.031 -0.016	0.714 +0.079 -0.041	1.44	4.82	0604D02.5-B15M1
15 BAR STD	3.125 +0.063 -0.063	7.938 +0.160 -0.160	0.281 +0.031 -0.016	0.714 +0.079 -0.041	2.15	81.03	0604D03-B15M1
15 BAR STD	4.125 +0.063 -0.063	10.478 +0.160 -0.160	0.281 +0.031 -0.016	0.714 +0.079 -0.041	3.75	106.34	0604D04-B15M1

SOILMOISTURE EQUIPMENT CORP.  
P.O. 30025, Santa Barbara, CA 93130  
Ofc: 801 S. Kellogg Ave., Goleta, CA. 93117  
<http://www.soilmoisture.com>  
PH: 1-805-964-3525 FAX 1-805-683-2189  
Contact: [sales@soilmoisture.com](mailto:sales@soilmoisture.com)





# POROUS

# CERAMICS

## 0630 CERAMIC RODS

Rods listed are "as cast". We can provide special rods to meet specific requirements. Soilmoisture technical staff may be contacted for more information on placing special orders.

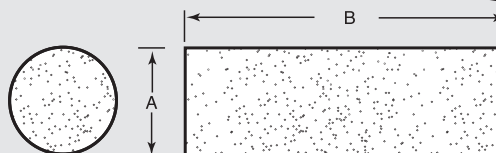

AIR ENTRY VALUE	DIMENSIONS/TOLERANCES						Part number
	A		B		Weight		
	Inches	cm	Inches	cm	oz.	gms	
<b>0.5 BAR HF</b>	<b>0.5</b>	<b>1.27</b>	<b>2.00</b>	<b>5.08</b>	<b>0.34</b>	<b>9.71</b>	<b>0630D00.5L2-B0.5M2</b>
	+0.020 -0.020	+0.051 -0.051	+0.063 -0.063	-0.160			
<b>0.5 BARHF</b>	<b>1.00</b>	<b>2.54</b>	<b>2.00</b>	<b>5.08</b>	<b>1.37</b>	<b>38.85</b>	<b>0630D01L2-B0.5M2</b>
	+0.020 -0.020	+0.051 -0.051	+0.063 -0.063	+0.160 -0.160			
<b>1 BAR HF</b>	<b>0.50</b>	<b>1.27</b>	<b>2.00</b>	<b>5.08</b>	<b>0.44</b>	<b>12.41</b>	<b>0630D00.5L2-B01M3</b>
	+0.020 -0.020	+0.051 -0.051	+0.063 -0.063	+0.160 -0.160			
<b>1 BAR HF</b>	<b>1.00</b>	<b>2.54</b>	<b>2.00</b>	<b>5.08</b>	<b>1.75</b>	<b>49.63</b>	<b>0630D01L2-B01M3</b>
	+0.020 -0.020	+0.051 -0.051	+0.063 -0.063	+0.160 -0.160			



SOILMOISTURE EQUIPMENT CORP.  
P.O. 30025, Santa Barbara, CA 93130  
Ofc: 801 S. Kellogg Ave., Goleta, CA. 93117  
http: //www.soilmoisture.com  
PH: 1-805-964-3525 FAX 1-805-683-2189  
Contact: sales@soilmoisture.com



## 0640 POROUS CERAMIC CYLINDERS

Cylinders listed are "as cast". Diameters can be machined to provide shoulders or special dimensions. We can also make up special cylinders to meet specific requirements. Soilmoisture's technical staff may be contacted for more information on placing special orders.

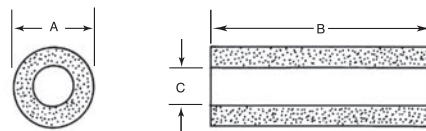

AIR ENTRY VALUE	DIMENSIONS/TOLERANCES								Part Number
	A		B		C		Weight		
	inches	cm	inches	cm	inches	cm	oz.	gms	
1 BAR STD	0.500 +0.063 -0.000	1.270 +0.160 -0.000	11.000 +0.063 -0.063	27.940 +0.160 -0.160	0.375 +0.075 -0.040	0.953 +0.191 -0.102	0.97	27.63	0640X05-B01M1
1 BAR HF	1.000 +0.063 -0.000	2.540 +0.160 -0.000	12.000 +0.063 -0.063	30.480 +0.160 -0.160	0.750 +0.020 -0.020	1.905 +0.051 -0.051	4.60	13.29	0640X07-B01M3
1 BAR HF	1.570 +0.063 -0.000	3.988 +0.160 -0.000	5.906 +0.063 -0.063	15.001 +0.160 -0.160	1.175 +0.020 -0.060	2.985 +0.051 -0.125	5.61	158.92	0640X08-B01M3
1 BAR HF	1.375 +0.063 -0.000	3.493 +0.160 -0.000	11.500 +0.063 -0.063	29.210 +0.160 -0.160	0.875 +0.020 -0.060	2.223 +0.051 -0.125	11.32	321.07	0640X09-B01M3

## 0651 FLAT BOTTOM, STRAIGHT WALL CUPS

Cups listed are "as cast". Please contact Soilmoisture's technical staff for special orders.

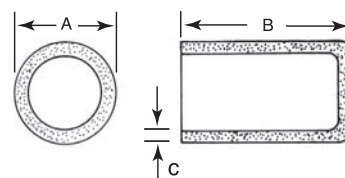

AIR ENTRY VALUE	DIMENSIONS/TOLERANCES								Part Number
	A		B		C		Weight		
	inches	cm	inches	cm	inches	cm	oz.	gms	
1 BAR STD	0.500 +0.030 -0.000	1.270 +0.076 -0.000	12.000 +0.250 -0.000	30.480 +0.635 -0.000	0.063 +0.030 -0.000	0.160 +0.076 -0.000	1.08	3.71	0651X02-B01M1

SOILMOISTURE EQUIPMENT CORP.  
P.O. 30025, Santa Barbara, CA 93130  
Ofc: 801 S. Kellogg Ave., Goleta, CA. 93117  
http://www.soilmoisture.com  
PH: 1-805-964-3525 FAX 1-805-683-2189  
Contact: sales@soilmoisture.com



## 0652 ROUND BOTTOM, STRAIGHT WALL CUPS

Cups listed are "as cast". We can cut these cups to make them shorter or cut off the closed ends to make cylinders. Diameters can be machined to provide shoulders or special dimensions. We can also make up special cups to meet specific requirements. Please contact Soilmoisture's technical staff for special orders.

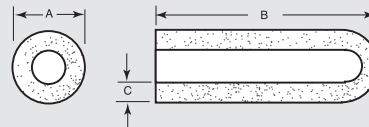

AIR ENTRY VALUE	DIMENSIONS/TOLERANCES								Part number
	A		B		C		Weight		
	Inches	cm	Inches	cm	oz.	gms	oz	gms	
<b>0.5 BAR HF</b>	<b>1.510</b> +0.063 -0.000	<b>3.988</b> +0.160 -0.000	<b>7.500</b> +0.090 -0.063	<b>17.050</b> +0.225 -0.160	<b>0.200</b> +0.063 -0.000	<b>0.508</b> +0.160 -0.000	<b>0.35</b>	<b>7.22</b>	<b>0652X18-B0.5M2</b>
<b>1 BAR STD</b>	<b>0.236</b> +0.030 -0.000	<b>0.599</b> +0.076 -0.000	<b>2.550</b> +0.063 -0.063	<b>6.477</b> +0.160 -0.160	<b>0.039</b> +0.030 -0.000	<b>0.099</b> +0.076 -0.000	<b>0.07</b>	<b>1.97</b>	<b>0652X01-B01M1</b>
<b>1 BAR STD</b>	<b>0.236</b> +0.030 -0.000	<b>0.599</b> +0.076 -0.000	<b>3.150</b> +0.063 -0.063	<b>8.001</b> +0.160 -0.160	<b>0.063</b> +0.030 -0.000	<b>0.160</b> +0.076 -0.000	<b>0.13</b>	<b>3.76</b>	<b>0652X02-B01M1</b>
<b>1 BAR STD</b>	<b>0.250</b> +0.030 -0.000	<b>0.635</b> +0.076 -0.000	<b>1.125</b> +0.063 -0.063	<b>2.858</b> +0.160 -0.160	<b>0.063</b> +0.030 -0.000	<b>0.160</b> +0.076 -0.000	<b>0.04</b>	<b>1.15</b>	<b>0652X03-B01M1</b>
<b>1 BAR STD</b>	<b>0.394</b> +0.030 -0.000	<b>1.001</b> +0.076 -0.000	<b>3.937</b> +0.063 -0.063	<b>10.000</b> +0.160 -0.160	<b>0.156</b> +0.030 -0.000	<b>0.396</b> +0.076 -0.000	<b>0.45</b>	<b>12.83</b>	<b>0652X04-B01M1</b>
<b>1 BAR STD</b>	<b>0.375</b> +0.030 -0.000	<b>0.953</b> +0.076 -0.000	<b>1.125</b> +0.063 -0.063	<b>2.858</b> +0.160 -0.160	<b>0.063</b> +0.030 -0.000	<b>0.160</b> +0.076 -0.000	<b>0.07</b>	<b>1.93</b>	<b>0652X07-B01M1</b>
<b>1 BAR STD</b>	<b>0.875</b> +0.030 -0.000	<b>2.223</b> +0.076 -0.000	<b>3.125</b> +0.090 -0.063	<b>7.938</b> +0.229 -0.160	<b>0.156</b> +0.030 -0.000	<b>0.396</b> +0.076 -0.000	<b>1.08</b>	<b>0.61</b>	<b>0652X08-B01M1</b>
<b>1 BAR STD</b>	<b>0.750</b> +0.030 -0.000	<b>1.905</b> +0.076 -0.000	<b>2.625</b> +0.090 -0.063	<b>6.668</b> +0.229 -0.160	<b>0.156</b> +0.030 -0.000	<b>0.396</b> +0.076 -0.000	<b>0.75</b>	<b>21.16</b>	<b>0652X16-B01M1</b>
<b>1 BAR HF</b>	<b>0.250</b> +0.030 -0.000	<b>0.635</b> +0.076 -0.000	<b>1.125</b> +0.063 -0.063	<b>2.858</b> +0.160 -0.160	<b>0.063</b> +0.030 -0.000	<b>0.160</b> +0.076 -0.000	<b>0.04</b>	<b>1.16</b>	<b>0652X03-B01M3</b>
<b>1 BAR HF</b>	<b>0.394</b> +0.030 -0.000	<b>1.001</b> +0.076 -0.000	<b>3.937</b> +0.063 -0.063	<b>10.000</b> +0.160 -0.160	<b>0.063</b> +0.030 -0.000	<b>0.160</b> +0.076 -0.000	<b>0.26</b>	<b>7.29</b>	<b>0652X04-B01M3</b>
<b>1 BAR HF</b>	<b>0.375</b> +0.030 -0.000	<b>0.953</b> +0.076 -0.000	<b>1.125</b> +0.063 -0.063	<b>2.858</b> +0.160 -0.160	<b>0.063</b> +0.030 -0.000	<b>0.160</b> +0.076 -0.000	<b>0.07</b>	<b>1.93</b>	<b>0652X07-B01M3</b>
<b>1 BAR HF</b>	<b>0.875</b> +0.030 -0.000	<b>2.223</b> +0.076 -0.000	<b>3.500</b> +0.090 -0.063	<b>8.890</b> +0.229 -0.160	<b>0.250</b> +0.030 -0.000	<b>0.653</b> +0.076 -0.000	<b>3.75</b>	<b>106.29</b>	<b>0652X09-B01M3</b>





## 0652 ROUND BOTTOM, STRAIGHT WALL CUPS

(Continued)

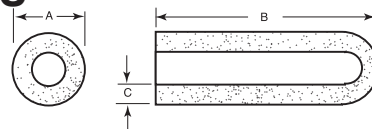

AIR ENTRY VALUE	DIMENSIONS/TOLERANCES								Part number
	A		B		C		Weight		
	Inches	cm	Inches	cm	oz.	gms	oz	gms	
1 BAR HF	0.875 +0.030 -0.000	2.223 +0.076 -0.000	3.500 +0.090 -0.063	8.890 +0.229 -0.160	0.125 +0.030 -0.000	0.318 +0.076 -0.000	2.61	74.10	0652X10-B01M3
1 BAR HF	0.500 +0.030 -0.000	1.270 +0.076 -0.000	2.500 +0.090 -0.063	6.350 +0.229 -0.160	0.125 +0.030 -0.000	0.318 +0.076 -0.000	0.36	1.30	0652X11-B01M3
1 BAR HF	0.750 +0.030 -0.000	1.905 +0.076 -0.000	2.625 +0.090 -0.063	6.668 +0.229 -0.160	0.156 +0.030 -0.000	0.396 +0.076 -0.000	0.75	21.36	0652X16-B01M3
1 BAR HF	1.570 +0.030 -0.000	3.988 +0.076 -0.000	7.500 +0.090 -0.063	19.050 +0.229 -0.160	0.200 +0.063 -0.000	0.508 +0.160 -0.000	32.04	908.24	0652X18-B01M3
2 BAR STD	0.375 +0.030 -0.000	0.953 +0.076 -0.000	1.125 +0.063 -0.063	2.858 +0.160 -0.160	0.063 +0.030 -0.000	0.160 +0.076 -0.000	0.07	1.91	0652X07-B02M1
3 BAR STD	0.375 +0.030 -0.000	0.953 +0.076 -0.000	1.125 +0.063 -0.063	2.858 +0.160 -0.160	0.063 +0.030 -0.000	0.160 +0.076 -0.000	0.07	1.92	0652X07-B03M1
5 BAR STD	0.375 +0.030 -0.000	0.953 +0.076 -0.000	1.125 +0.063 -0.063	2.858 +0.160 -0.160	0.063 +0.030 -0.000	0.160 +0.076 -0.000	0.07	1.92	0652X07-B05M1

SOILMOISTURE EQUIPMENT CORP.  
P.O. 30025, Santa Barbara, CA 93130  
Ofc: 801 S. Kellogg Ave., Goleta, CA. 93117  
http://www.soilmoisture.com  
PH: 1-805-964-3525 FAX 1-805-683-2189  
Contact: sales@soilmoisture.com



# POROUS

# CERAMICS

## 0653 ROUND BOTTOM NECK TOP CUPS

Cups listed are "as cast". Please contact Soilmoisture's technical staff for special orders.

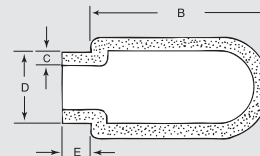
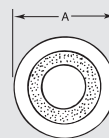

AIR ENTRY VALUE	DIMENSIONS/TOLERANCES										PART NUMBER/WEIGHT
	A		B		C		D		E		
	Inches	cm	Inches	cm	oz.	gms	Inches	cm	inches	cm	
0.5 BAR HF	1.900 +0.060 -0.000	4.826 +0.152 -0.000	2.380 +0.063 -0.063	6.045 +0.160 -0.160	0.094 +0.061 -0.000	0.239 +0.155 -0.000	1.725 +0.010 -0.015	4.382 +0.025 -0.038	0.438 +0.063 -0.063	1.113 +0.160 -0.160	0653X01-B0.5M2 1.48oz/42.01gms
0.5 BAR HF	1.900 +0.060 -0.000	4.826 +0.152 -0.000	2.380 +0.063 -0.063	6.045 +0.160 -0.160	0.156 +0.030 -0.000	0.396 +0.076 -0.000	1.725 +0.010 -0.015	4.382 +0.025 -0.038	0.438 +0.063 -0.063	1.113 +0.160 -0.160	0653X02-B0.5M2 2.40oz/67.96gms
1 BAR STD	1.417 +0.060 -0.000	3.599 +0.152 -0.000	2.950 +0.063 -0.063	7.493 +0.160 -0.160	0.095 +0.040 -0.000	0.241 +0.102 -0.000	1.024 +0.030 -0.000	2.601 +0.076 -0.000	0.787 +0.063 -0.063	1.999 +0.160 -0.160	0653X06-B01M1 1.45oz/41.07gms
1 BAR HF	1.900 +0.060 -0.000	4.826 +0.152 -0.000	2.380 +0.063 -0.063	6.045 +0.160 -0.160	0.094 +0.061 -0.000	0.239 +0.155 -0.000	1.725 +0.010 -0.015	4.382 +0.025 -0.038	0.438 +0.063 -0.063	1.113 +0.160 -0.160	653X01-B01M3 1.60oz/45.31gms
1. BAR HF	1.900 +0.060 -0.000	4.826 +0.152 -0.000	2.380 +0.063 -0.063	6.045 +0.160 -0.160	0.156 +0.030 -0.000	0.396 +0.076 -0.000	1.725 +0.010 -0.015	4.382 +0.025 -0.038	0.438 +0.063 -0.063	1.113 +0.160 -0.160	0653X02-B01M3 2.58oz/73.09gms
1 BAR HF	2.375 +0.060 -0.000	6.033 +0.152 -0.000	2.130 +0.063 -0.063	5.410 +0.160 -0.160	0.125 +0.030 -0.000	0.318 +0.076 -0.000	2.020 +0.030 -0.000	5.131 +0.076 -0.000	0.375 +0.063 -0.063	0.953 +0.160 -0.160	0653X05-B01M3 2.47 oz/7.05gms
1 BAR HF	1.900 +0.060 -0.000	4.826 +0.152 -0.000	10.00 +0.063 -0.063	25.400 +0.160 -0.160	0.156 +0.030 -0.000	0.396 +0.076 -0.000	1.000 +0.030 -0.000	2.540 +0.076 -0.000	1.125 +0.063 -0.063	2.858 +0.160 -0.160	0653X07-B01M3 9.37oz/265.52gms
2 BAR HF	1.900 +0.060 -0.000	4.826 +0.152 -0.000	2.380 +0.063 -0.063	6.045 +0.160 -0.160	0.094 +0.061 -0.000	0.239 +0.155 -0.000	1.725 +0.010 -0.015	4.382 +0.025 -0.038	0.438 +0.063 -0.063	1.113 +0.160 -0.160	0653X01-B02M2 1.53oz/42.34gms
2 BAR HF	1.900 +0.060 -0.000	4.826 +0.152 -0.000	2.380 +0.063 -0.063	6.045 +0.160 -0.160	0.156 +0.030 -0.000	0.396 +0.076 -0.000	1.725 +0.010 -0.015	4.382 +0.025 -0.038	0.438 +0.063 -0.063	1.113 +0.160 -0.160	0653X02-B02M2 2.46oz/69.87gms



SOILMOISTURE EQUIPMENT CORP.  
P.O. 30025, Santa Barbara, CA 93130  
Ofc: 801 S. Kellogg Ave., Goleta, CA. 93117  
http://www.soilmoisture.com  
PH: 1-805-964-3525 FAX 1-805-683-2189  
Contact: sales@soilmoisture.com



## 0655 ROUND BOTTOM TAPERED NECK CUPS

Cups listed are "as cast". Please contact Soilmoisture's technical staff for special orders.

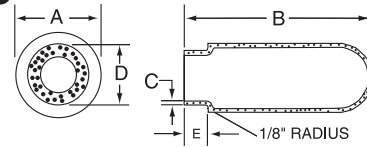

AIR ENTRY VALUE											PART NUMBER/WEIGHT
	A		B		C		D		E		
	Inches	cm	Inches	cm	oz.	gms	Inches	cm	inches	cm	
<b>0.5 BAR HF</b>	<b>0.875</b> +0.030 -0.020	<b>2.223</b> +0.076 -0.051	<b>2.750</b> +0.063 -0.063	<b>6.985</b> +0.160 -0.160	<b>0.100</b> +0.050 -0.000	<b>0.254</b> +0.127 -0.000	<b>0.531</b> +0.035 -0.015	<b>1.349</b> +0.089 -0.038	<b>0.500</b> +0.063 -0.063	<b>17.07</b> +0.160 -0.160	<b>0655X01-B0.5M2</b> 1.270oz/.60gms
<b>1 BAR HF</b>	<b>0.875</b> +0.030 -0.020	<b>2.223</b> +0.076 -0.051	<b>2.750</b> +0.063 -0.063	<b>6.985</b> +0.160 -0.160	<b>0.100</b> +0.050 -0.000	<b>0.254</b> +0.127 -0.000	<b>0.531</b> +0.035 -0.015	<b>1.349</b> +0.089 -0.038	<b>0.500</b> +0.063 -0.063	<b>1.270</b> +0.160 -0.160	<b>0655X01-B01M3</b> 0.60oz/17.03gms
<b>1 BAR STD</b>	<b>0.875</b> +0.030 0.020	<b>2.223</b> +0.076 -0.051	<b>2.750</b> +0.063 -0.063	<b>6.985</b> +0.160 -0.160	<b>0.100</b> +0.050 -0.000	<b>0.254</b> +0.127 -0.000	<b>0.531</b> +0.035 -0.015	<b>1.349</b> +0.089 -0.038	<b>0.500</b> +0.063 -0.063	<b>1.270</b> +0.160 -0.160	<b>0655X01-B01M1</b> 0.65oz/18.45gms

SOILMOISTURE EQUIPMENT CORP.  
P.O. 30025, Santa Barbara, CA 93130  
Ofc: 801 S. Kellogg Ave., Goleta, CA. 93117  
http: //www.soilmoisture.com  
PH: 1-805-964-3525 FAX 1-805-683-2189  
Contact: sales@soilmoisture.com



# POROUS

# CERAMICS



## CUSTOM SHAPES 0660 SERIES

- A wide selection of air entry values
- Specialized glazing of surfaces
- Secondary machining of cast parts
- Fired as assembly/multiple parts
- Available in small or large quantities
- Holes, grooves and undercuts possible
- Full Assemblies or Sub-Assemblies available
- We'll assemble and test completed units
- Lets us join our ceramics to your acrylic, polycarbonate, Teflon, glass or metal idea

## FEATURES & APPLICATIONS

The 0660 Series provides a few unusual examples shown below, that can be adapted or used directly on your special project. Our special ceramics and custom shapes have been used in a wide variety of applications and configurations to meet the most demanding needs. From the more mundane areas of agricultural and petroleum research to unique shields for underground nuclear blasts or specialized interface products in hydroponics, we can provide the solution. No matter what your interest, we have the facilities, background, and expertise to fabricate a porous ceramic product that will meet or exceed your goals.

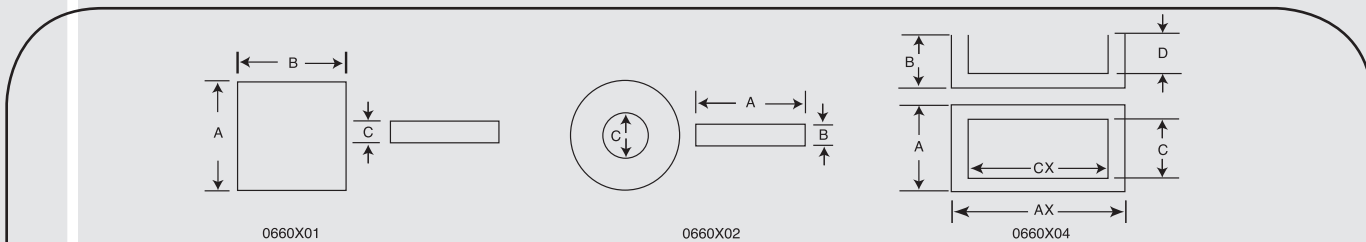
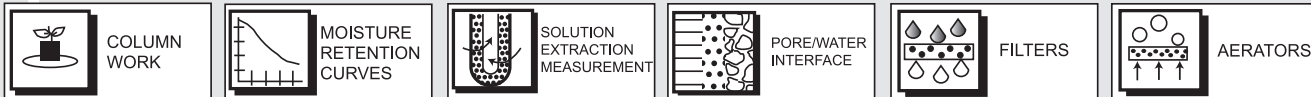

AIR ENTRY VALUE	DIMENSIONS/TOLERANCES										
	A		B		C		D		Weight		Part number
	Inches	cm	Inches	cm	oz.	gms	oz	gms	oz	gms	
1 BAR HF	2.00	5.08	2.00	5.08	0.25	0.64			0.05	0.11	0660X01-B01M3
1 BAR HF	2.00	5.08	0.25	0.64	1.00	2.54			0.02	0.06	0660X02-B01M3
1 BAR HF	1.00 x 2.00	2.54 x 5.08	0.50	1.27	0.80 x 1.80	2.03 x 4.57	0.30	0.76	0.05	0.12	0660X04-B01M3

Tolerances A,B +/- .063; C=+/- 0.030; D=+0.030/-0.000



SOILMOISTURE EQUIPMENT CORP.  
 P.O. 30025, Santa Barbara, CA 93130  
 Ofc:801 S. Kellogg Ave., Goleta, CA. 93117  
<http://www.soilmoisture.com>  
 PH: 1-805-964-3525 FAX 1-805-683-2189  
 Contact: sales@soilmoisture.com

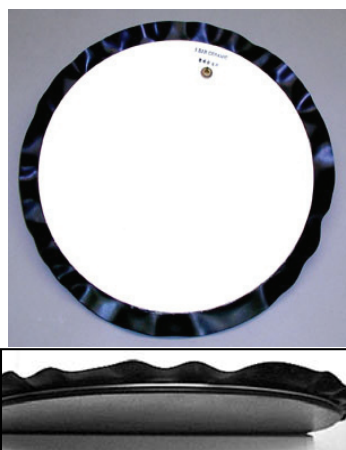

### PRESSURE PLATE CELLS 0675 SERIES

- The global standard used for soil water retention measurements and extractions
- The widest selection of 0.5 bar to 15 bar
- Reusable for years of cost effective service
- Each plate tested for air entry and flow
- Fits all Soilmoisture pressure extractors and most competitive extractors

#### TYPICAL APPLICATIONS



These pressure plate cells have been the de-facto standard for the measurement of soil moisture retention studies worldwide. The development of these ceramic cells by Soilmoisture in the 1950's led to the now universally accepted method for measurement of multiple soil samples extracted on a single reusable ceramic plate. Researchers' dedication to our Soilmoisture cells is understandable. Each cell is carefully hand fabricated from our fine porous ceramic plate materials and wrapped in a tough Butyl rubber backing with a non-metallic screen support. The unit is tied around the edges with stainless steel wire. Each cell is tested at the rated air entry value to assure that there is no bleeding through the porous ceramic and there are no leaks in the rubber backing.

AIR ENTRY VALUE	DIMENSIONS/TOLERANCES						PART NUMBER
	DIAMETER		THICKNESS		WEIGHT		
	Inches	cm	inches	cm	oz	gms	
5 BAR HF	10.50	26.67	0.375	0.953	1.03	2.28	0675B0.5M2
1 BAR	10.75	27.30	0.276	0.701	1.02	2.26	0675B01M1
1 BAR HF	10.50	26.67	0.375	0.953	0.78	1.73	0675B01M3
3 BAR	10.75	27.30	0.276	0.701	1.00	2.20	0675B03M1
5 BAR	10.75	27.30	0.276	0.701	1.05	2.31	0675B05M1
15 BAR	10.19	25.88	0.234	0.594	0.81	1.80	0675B15M1

Packaged Sets of Plates are also available for your plate extractors Model 1500 and 1600.

- 0675 PKG1FUL 1ea. Our complete range of porous plates Includes, B0.5M2, B01M1, B01M3, B03M1, B05M1, B15M1
- 0675PKG2B01HF 2ea. Range of High Flow (HF) porous plates for 1 BAR includes B0.5M2 and B01M3 plates.
- 0675PKG4B01HF 4ea Range of High Flow (HF) porous plates for 1 BAR includes B0.5M2 and B01M3 plates.
- 0675PKG8B01HF 8ea Range of High Flow (HF) porous plates for 1 BAR includes B0.5M2 and B01M3 plates
- 0675PKG2B05 2ea. Range of porous plates for 5 Bar extractions, includes, B01M1, B03M1, B05M1
- 0675PKG4B05 4ea. Range of porous plates for 5 Bar extractions, includes, B01M1, B03M1, B05M1
- 0675PKG8B05 8ea. Range of porous plates for 5 Bar extractions, includes, B01M1, B03M1, B05M1
- 0675PKG2B15 2ea. Range of porous plates for 15 Bar extractions, includes, B01M1, B03M1, B05M1, and B15M1
- 0675PKG4B15 4ea. Range of porous plates for 15 Bar extractions, includes, B01M1, B03M1, B05M1, and B15M1
- 0675PKG8B15 8ea. Range of porous plates for 15 Bar extractions, includes, B01M1, B03M1, B05M1, and B15M1

Specific porous plates can also be ordered in sets of 2ea (0675PKG2), 4ea (0675PKG4), and 8 ea (0675PKG8). Please specify the Bar and Mix for example -4ea., B01M3 plates is ordered as "0675PKG4-B01M3"

SOILMOISTURE EQUIPMENT CORP.  
 P.O. 30025, Santa Barbara, CA 93130  
 Ofc: 801 S. Kellogg Ave., Goleta, CA. 93117  
<http://www.soilmoisture.com>  
 PH: 1-805-964-3525 FAX 1-805-683-2189  
 Contact: sales@soilmoisture.com





# POROUS

# CERAMICS



## MODEL 0676 SOIL RETAINER ASSEMBLIES

- The preferred way to handle undisturbed or prepared soil samples for water retention studies
- Simple construction and easy maintenance
- Transport samples to and from weighings without disturbance

### FEATURES

These useful assemblies are used in conjunction with sampling equipment using “undisturbed” soil samples or prepared samples for discrete determination of soil water retention characteristics. The unit consists of a 1/4 in. x 2-1/4 in. ceramic plate with stainless steel tie downs, clear plastic cover and 3 cm long brass sampling cylinder (Model 0206L03).

### TYPICAL APPLICATIONS

The 0676 allows researchers to measure a single sample over extended pressure ranges in conjunction with moisture retention measurements. Once wetted to saturation, the sample within the brass cylinder can easily be placed on an intermediate particle bed covering the pressure plate cell and pressurized to a specific value. Upon reaching a state of equilibrium, the extractor is opened and the sample retainer assembly is weighed and then returned to the extractor for the next pressure value. This method allows the researcher a quick and repeatable way to measure the same sample accurately over numerous pressure values. It eliminates the need for large quantities of replacement samples for each pressure value.

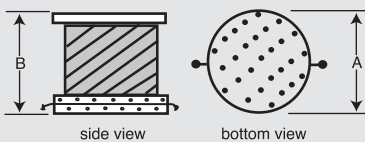
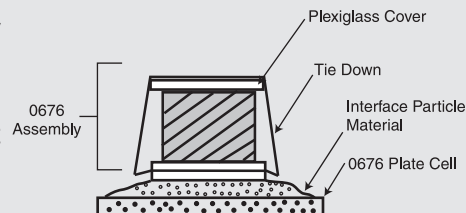

AIR ENTRY VALUE	DIMENSIONS/TOLERANCES						PART NUMBER
	A		B		Weight		
	Inches	cm	Inches	cm	oz	gms	
1 BAR STD	2.25	5.72	1.50	3.81	4.64	130	0676



SOILMOISTURE EQUIPMENT CORP.  
 P.O. 30025, Santa Barbara, CA 93130  
 Ofc: 801 S. Kellogg Ave., Goleta, CA. 93117  
 http://www.soilmoisture.com  
 PH: 1-805-964-3525 FAX 1-805-683-2189  
 Contact: sales@soilmoisture.com

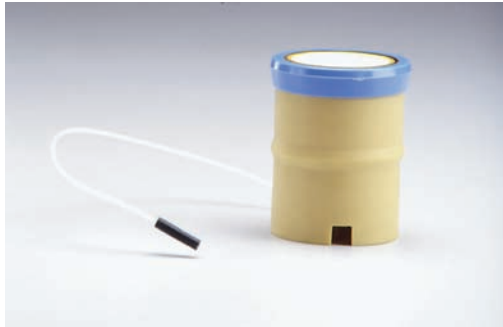

### MODEL 0685 POROUS CUP ASSEMBLIES

- Fast determination of prepared soil samples
- Available in 1 and 15 bar values
- Small, compact, fits most all extractors
- A controlled suction environment for growth

### FEATURES

This injection molded outer elastomer casing and tough interior porous ceramic cup make it a great combination. The elastomer protects the ceramic from damage and adjusts to applied pressures while the porous ceramic provides an easy interface for water pushed from the sample. A sandwiched coarse nylon screen provides a continuous drainage path for the water. The enormous interior surface area of the cup makes it an ideal receptacle for large prepared samples that must reach equilibrium quickly, reducing waiting times by factors of 10 or more in many cases. All parts are nonmetallic, permanently joined, and free from possible contamination from volatile sealants or compounds.

### TYPICAL APPLICATIONS

The 0685 Series are generally used for the quick determination of soil moisture retention values. The development of a moisture retention curve is much easier and accurate with a cup assembly that can be removed and weighed without disturbing the sample. The large interior ceramic surface areas assure reaching equilibrium in the fastest time possible. Of course, the adaptable unit can be used in the extractor for pressure extractions of pastes and thick solutions or outside the extractor for stand alone, weighable, suction environments for seedlings and other small plants.

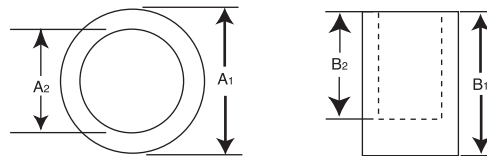

AIR ENTRY VALUE	DIMENSIONS/TOLERANCES										
	A <sub>1</sub>		A <sub>2</sub>		B <sub>1</sub>		B <sub>2</sub>		WEIGHT		PART NUMBER
	Inches	cm	Inches	cm	oz	gms					
1 BAR HF	2.40	6.10	1.76	4.47	3.20	8.13	2.21	5.61	7.20	220	0685B01F
15 BAR	2.40	6.10	1.76	4.47	3.20	8.13	2.21	5.61	6.72	190	0685B15F

SOILMOISTURE EQUIPMENT CORP.  
P.O. 30025, Santa Barbara, CA 93130  
Ofc: 801 S. Kellogg Ave., Goleta, CA. 93117  
http://www.soilmoisture.com  
PH: 1-805-964-3525 FAX 1-805-683-2189  
Contact: sales@soilmoisture.com



## ACCESSORY ITEMS



### model 0980 Epoxy kits

Soilmoisture's Model 0980 Epoxy Kit is a clean, time proven, 2-part, semi-flexible inert epoxy joining material in kit form. A superb combination (Furane-type epoxy and hardener) that, when mixed together, is capable of joining materials of dissimilar coefficients of expansion.

The epoxy makes an excellent seal for porous ceramics and such dissimilar materials as PVC pipe, neoprenes, and Butyl elastomers.

Since this epoxy process contains no activators and uses nonvolatile organic components, it provides contaminate-free joints and seals. In addition the epoxy is virtually inert to most all bases, acids, and salts making it perfect for sensitive research and tough operating environments. It is not recommended for use with lucite. Each kit contains equal amounts of epoxy and hardener.

0980V004	04oz Kit (Epoxy & Hardener, makes a total of 8 oz.)
0980V016	16oz Kit (Epoxy & Hardener, makes a total of 32 oz.)
0980V032	32oz Kit (Epoxy & Hardener, makes a total of 64 oz.)

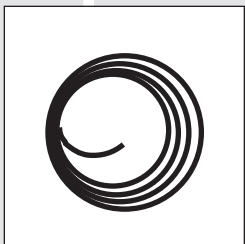

### model MRT series Rubber Tubing

The MRT series is a selection of black opaque Neoprene or Butyl tubing you may find helpful for your specific project. Since Neoprene and Butyl are hardy and stretchable synthetic rubbers they make good primary flexible joints, they also act as a link to join the more rigid parts and tubing sections sometimes of fairly dissimilar size. In general, a Butyl product has fewer ingredients and amendments and is considered a "cleaner" product.

1/16" .062 ( 15.7 mm) INSIDE DIAMETER  
 1901RED062L010 EPDM ELASTOMER CONNECTING TUBING .062 in (15.7 mm) Dia., .062 in (15.7 mm) Wall, 10 ft.  
 1901RED062L025 EPDM ELASTOMER CONNECTING TUBING .062 in (15.7 mm) Dia., .062 in (15.7 mm) Wall, 25 ft.  
 1901RED062L050 EPDM ELASTOMER CONNECTING TUBING .062 in (15.7 mm) Dia., .062 in (15.7 mm) Wall, 50 ft.

3/16" .187 ( 63.5 mm) INSIDE DIAMETER  
 1901RED187L010 EPDM ELASTOMER CONNECTING TUBING .187 in (47.7 mm) Dia., .125 in (31.7 mm) Wall, 10 ft.  
 1901RED187L025 EPDM ELASTOMER CONNECTING TUBING .187 in (47.7 mm) Dia., .125 in (31.7 mm) Wall, 25 ft.  
 1901RED187L050 EPDM ELASTOMER CONNECTING TUBING .187 in (47.7 mm) Dia., .125 in (31.7 mm) Wall, 50 ft.

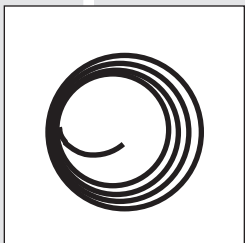

### model MYT series nylon tubing

The MYT series is a selection of translucent white Nylon tubing available to transport solutions, water, and air, to and from ceramics parts and assemblies. The tough tubing is perfect for field and commercial use where elevated pressures and vacuums may be applied. It should be remembered that Nylon will absorb a small water content over time lengthening the tubing; of course the reverse is true once wetted.

1/8" .125 ( 31.7 mm) OUTSIDE DIAMETER  
 1901PND125L025 NYLON ACCESS TUBING, .125 in (31.7 mm) Dia., .031 in (7.87 mm) Wall, 25 ft.  
 1901PND125L050 NYLON ACCESS TUBING, .125 in (31.7 mm) Dia., .031 in (7.87 mm) Wall, 50 ft.  
 1901PND125L100 NYLON ACCESS TUBING, .125 in (31.7 mm) Dia., .031 in (7.87 mm) Wall, 100 ft.  
 1901PND125L500 NYLON ACCESS TUBING, .125 in (31.7 mm) Dia., .031 in (7.87 mm) Wall, 500 ft.

1/4" .250 ( 63.5 mm) OUTSIDE DIAMETER  
 1901PND250L025 NYLON ACCESS TUBING, .250 in (63.5 mm) Dia., .031 in (7.87 mm) Wall, 25 ft.  
 1901PND250L050 NYLON ACCESS TUBING, .250 in (63.5 mm) Dia., .031 in (7.87 mm) Wall, 50 ft.  
 1901PND250L100 NYLON ACCESS TUBING, .250 in (63.5 mm) Dia., .031 in (7.87 mm) Wall, 100 ft.  
 1901PND250L500 NYLON ACCESS TUBING, .250 in (63.5 mm) Dia., .031 in (7.87 mm) Wall, 500 ft.



SOILMOISTURE EQUIPMENT CORP.  
 P.O. 30025, Santa Barbara, CA 93130  
 Ofc:801 S. Kellogg Ave., Goleta, CA. 93117  
<http://www.soilmoisture.com>  
 PH: 1-805-964-3525 FAX 1-805-683-2189  
 Contact: sales@soilmoisture.com



## ACCESSORY ITEMS

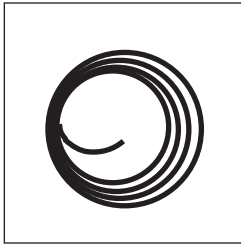

### **model MBT series copper tubing**

Used for evacuation of soil water samples which utilize our porous ceramic cups and plates.

MBT013L50 1/4" O.D. x .030" wall, 50 ft. roll

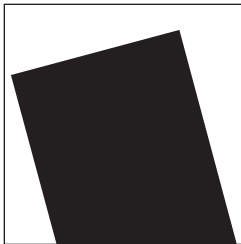

### **model MRF butyl sheeting**

Used for backing on our porous ceramic plates and as rubber boots in our porous ceramic cup assemblies.

MRF 002-003 36" wide sold by linear foot

SOILMOISTURE EQUIPMENT CORP.  
P.O. 30025, Santa Barbara, CA 93130  
Ofc: 801 S. Kellogg Ave., Goleta, CA. 93117  
<http://www.soilmoisture.com>  
PH: 1-805-964-3525 FAX 1-805-683-2189  
Contact: [sales@soilmoisture.com](mailto:sales@soilmoisture.com)

## Formulas or Mixes (M) and associated specific (B) Bar values:

### **B0.5 - 1/2 Bar (7.25 psi or 50KPa) Air Entry Ceramics**

#### **CERAMIC-B0.5M2**

This ceramic is developed from a high fired, Alumina body. The resulting ceramic is an excellent material which is extremely porous, inert to most all solutions, possesses hard exterior and interior surfaces, and is pure white in color. This material is recommended for low pressure differentials not exceeding 7.4 psi. The tremendous porosity and high conductivity of fluids or gases make it ideal for quick extractions or in creating, monitoring or extracting pulse hydrological events. The material is ideal for liquid or gas sampling as the Alumina material has almost no ionic exchange sites or "leachable" mineralogy. This is a truly superior ceramic for both industrial and scientific work where high volume transfer or testing at low pressure differentials is necessary .

### **B01 - 1 Bar (14.5 psi or 100KPa) Air Entry Ceramics**

#### **CERAMIC-B01M1**

This ceramic is developed from a moderately fired largely Talc body. The resulting ceramic material, made from a time proven formula, is a utilitarian ceramic having good porosity, tough exterior and interior surfaces, and is ivory white in color. This material is recommended for general purpose uses that involve pressure differentials under 15 psi. This ceramic is an excellent choice where cost and precise content of fluids or extracts are not at issue. This material has been applied successfully to tensiometers, pressure plate assemblies, suction tables and the like for nearly 50 years. This ceramic is not recommended for precision fluid sampling work as it has some ionic exchange sites and a mineralogy that is leachable with strong acids over the years. This is the perfect choice for those needing a low cost industrial ceramic product or where the science requires minimal fluid content determinations.

#### **CERAMIC-B01M3**

This ceramic, like the B0.5M2, is developed from a high fired Alumina body. The resulting ceramic is an excellent material. It is extremely porous, inert to most all solutions, possesses hard exterior and interior surfaces, and is pure white in color. This material is recommended for standard pressure differentials not exceeding 15 psi. The tremendous porosity and ability to conduct large amounts of fluids or gases makes it ideal for quick extractions, and creating, monitoring or extracting pulse hydrological events. The material is ideal for liquid or gas sampling as the Alumina material has almost no ionic exchange sites or "leachable" mineralogy. A great material for most any application involving sampling, testing, monitoring or infusion where precision and actual liquid contents are of importance.

### **B02 - 2 Bar (29.4 psi or 200KPa) Air Entry Ceramics**

#### **CERAMIC - B02M1**

This ceramic is developed from a variety of ball clays into a moderately fired ceramic body. The fired product has an effective porosity and good hydrologic flow capability. Bubbling pressures for this ceramic are pressure differentials less than 29.4 psi. This general use ceramic is most often used on specialized plates for soil water retention or in unique oil and gas industries for reclamation studies. The material is moderately hard and creamy white in color. This ceramic is recommended for specialized applications using plates.





### **B02 - 2 Bar (29 psi or 200KPa) Air Entry Ceramics**

#### **CERAMIC - B02M2**

This porcelain ceramic is developed from a high fire Silica body. The resulting ceramic is an excellent material for slightly elevated pressure differentials not exceeding 29.4 psi. The material has a somewhat grainy texture and pure white appearance. A good material for sampling fluids and gases as porcelain has few ionic exchange sites or “leachable” mineralogy. With the good porosity and hydrologic characteristics, this ceramic provides a material that can be used by oil companies or agricultural research scientists. This ceramic is an excellent choice for those needing the added capacity of elevated pressure differentials and precise fluid content measurements.

### **B03 - 3 Bar (43.5 psi or 300Kpa) Air Entry Ceramics**

#### **CERAMIC B03M1**

This ceramic is developed from a complex mixture of ball clays into a moderately fired ceramic body. The resulting ceramic has good porosity and good hydrologic flow capability. Bubbling pressures for this ceramic are pressure differentials exceeding 44 psi. This ceramic is generally used within pressure vessel equipment for the determination of soil water retention or in oil and gas industries for reclamation studies. The material is moderately hard and tannish-white in color. This ceramic is recommended for specialized applications where the differential pressures will be less than 44 psi.

### **B05 - 5 Bar (72.5 psi or 500Kpa) Air Entry Ceramics**

#### **CERAMIC - B05M1**

This ceramic, like the “B03M1”, is developed from a complex mixture of ball clays into a fired ceramic body. The resulting ceramic has good porosity and good hydrologic flow capability. Bubbling pressure or air entry values are pressure differentials exceeding 74 psi or greater. It is generally used within pressure vessel equipment for the determination of soil water retention or in oil and gas industries for reclamation studies. The material is very hard and brownish-white in color. This ceramic is recommended for specialized applications where the differential pressures will be less than 74 psi.

### **B15 - 15 Bar (217.5 psi or 1500KPa) Air Entry Ceramics**

#### **CERAMIC - B15M1**

This ceramic is developed from a proprietary mixture of ball clays fired to a ceramic body. The resulting ceramic material is pinkish-tan in color, moderately hard and will withstand pressure differentials of 220 psi. This unique ceramic, incorporated into 0675 pressure plate cells, has been used in Agronomy for many years in water retention studies to a theoretical wilting point of 15 bars. It has also found use in the oil and gas industries in studies of reclamation and production techniques. It remains the worldwide choice of experts when they need to know the behavior of liquids to a 3 dimensional porous material that mimics soil and stone. The B15M1 is still the only ceramic in the world that, when wetted, can withstand a pressure differential of 220 psi and not leak or bubble. The unique characteristics of the B15M1 ceramic make it the selection of experts and scientists who are involved in liquid movements and transfer conditions at elevated pressure differentials.

### **NOTE: Formulas and Mixes**

The above formula descriptions for our ceramics are keyed to the “bubbling” (B) or air entry value of a ceramic. There may be one or more “mixes” (M) associated with a particular air entry value. M1 will denote the first formula, M2 the second, and so forth. An example of this non-relationship: M1 mix for a B1 (one bar air entry value) is not in any manner related to the mix or formula M1 for a B5 (five bar entry value ceramic).

## Glazing

All glazing used in conjunction with the fabrication of standard or special products is of highest quality and contains no lead. How to specify or heavy metals that could leach into solution samples. Glazes come in several firing temperatures and can be applied in one or two step processes to meet the most demanding requirements. Glazing can also be applied to one or more surfaces to create the wicking or capillary pathways of desired width and direction.

## HELPFUL HINTS

### ACID WASHING A CERAMIC? - IT'S GENERALLY NOT NEEDED

There are some who believe that all ceramics need to be washed with a strong acid to "clean" pores of possible ionic exchange sites prior to use in liquid sampling. This misconception is based upon older ceramic mix formulas (1960's) of moderately fired ceramics such as our B01M1 which has a talc component with potential ion exchange sites. In those early cases, some ionic exchange did occur during the first sampling periods as weak mineralogical lattice sites exchanged larger ions for more highly charged smaller ions. In reality, however, after several weeks in situ the transfer of ions was completed and the saturated lattice sites within the ceramic were at equilibrium with local soil waters. Acid washing cleaned most of the susceptible lattice sites in pore areas of these moderately fired ceramics leaving new holes within the ceramic lattice. As before, the first samples lacked uniformity with pore water content as the highly charged ions found these preferential "cleaned" mineralogical sites within the ceramic. After several weeks of installation and use, the cleaned sampler ionic sites were saturated and at equilibrium with the surrounding soil waters.

For solution sampling we recommend only the use of high fired, very stable and clean porous ceramics like the B0.5M2, B01M3, B02M2 that provide not only the hydraulic properties and air entry values that far exceed older formulas, but also possess the levels of cleanliness and stability designed for liquid content sampling. Even these extremely clean ceramics may, upon first use, attract some cations that have an affinity for the generally negative surfaces within the ceramic. All naturally hydrophilic materials will have these tendencies to affect initial ionic content in some slight manner no matter how pure and inert the hydrophilic material. The rule of thumb is "pore structure and pore liquids reach an equilibrium state after 5 to 8 pore volumes have traveled the pore spaces". This is the reason why the first several samples should be ignored as the samples will probably not precisely represent the actual pore fluids.

## IF YOU MUST WASH

If you must consider solution sampling using our moderately fired materials such as B01M1, B03M1, B05M1, B15M1 (not recommended for solution sampling), we would suggest a simple acid wash as described below:

Prepare a 1 Normal solution Hydrochloric Acid (HCl) and pass 30 pore volumes of the acid wash through the ceramic by gravity or slight pressure. Rinse with 20 pore volumes of deionized or distilled water.

Again, as pointed out earlier, the washing process will result in a ceramic that has a fair amount of empty lattice sites waiting to snag the unwary ionic traveler. Once in situ, these sites are filled and a state of equilibrium will exist between soil solution contents and pore solution contents.





### How to specify special ceramics

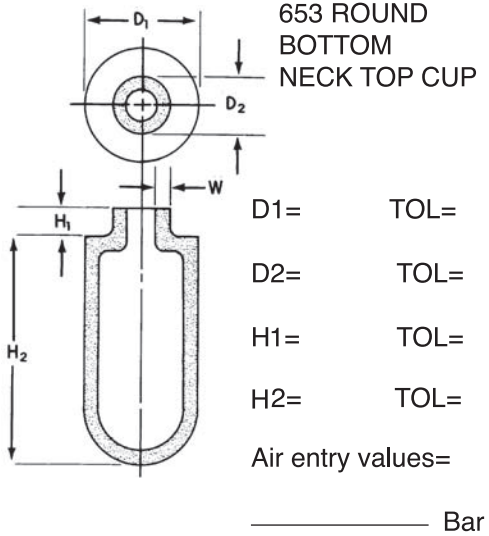
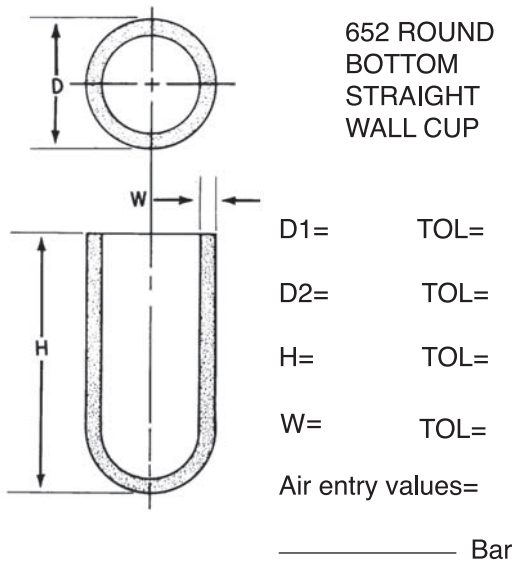
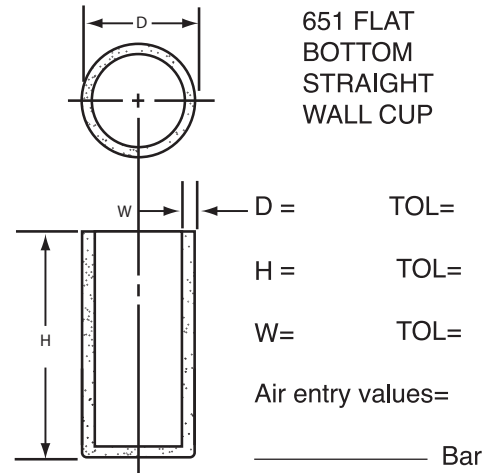
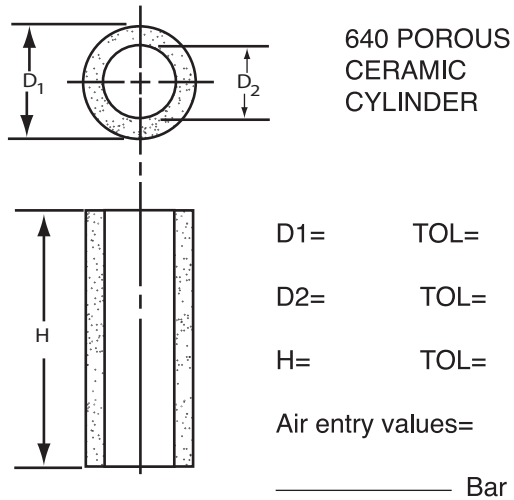

Remember that you can request specialized machining or glazing on your parts as well.

SOILMOISTURE EQUIPMENT CORP.  
P.O. 30025, Santa Barbara, CA 93130  
Ofc: 801 S. Kellogg Ave., Goleta, CA. 93117  
http://www.soilmoisture.com  
PH: 1-805-964-3525 FAX 1-805-683-2189  
Contact: sales@soilmoisture.com





# POROUS

# CERAMICS

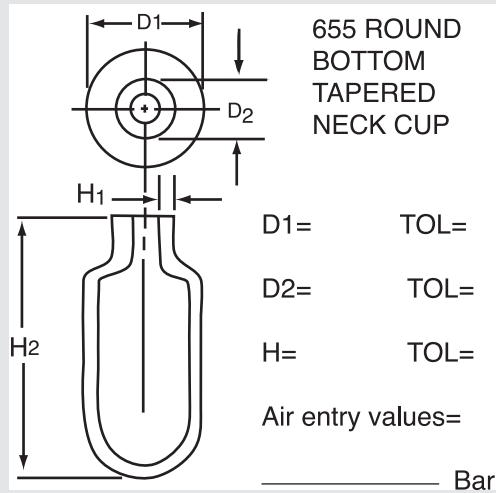

### Special Ceramics Specifications

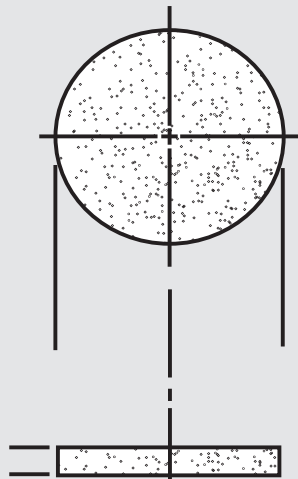

SPECIAL ROUND CERAMIC PLATE

D=      TOL=

T=      TOL=

Air entry values= \_\_\_\_\_ Bar

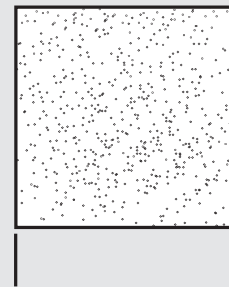

SPECIAL SQUARE CERAMIC PLATE

D=      TOL=

T=      TOL=

Air entry values= \_\_\_\_\_ Bar

Remember that you can request specialized machining or glazing on your parts as well.



SOILMOISTURE EQUIPMENT CORP.  
P.O. 30025, Santa Barbara, CA 93130  
Ofc: 801 S. Kellogg Ave., Goleta, CA. 93117  
<http://www.soilmoisture.com>  
PH: 1-805-964-3525 FAX 1-805-683-2189  
Contact: [sales@soilmoisture.com](mailto:sales@soilmoisture.com)