2710ARL/2725ARL **OPERATING INSTRUCTIONS**

2710ARL Tensiometer and 2725ARL Jet Fill Tensiometer

March 2011



(Fig. 1a) 2710ARL Tensiometer



(Fig. 1b) 2725ARL Jet Fill Tensiometer

The Model 2710ARL Tensiometers and the 2725ARL Jet Fill Tensiometers, are simple, versatile, and inexpensive instruments that provide a direct measurement of soil water tension.

UNPACKING

Remove all packing material carefully. Do not bump or drop the dial gauge or ceramic sensing tip or they could break and will need to be replaced. Take care not to let the sensing tip come in contact with grease or any other similar material that could clog the pores of the ceramic.

Please verify that your shipment is complete. Your order should have a ceramic sensing tip and dial gauge for each tensiometer ordered. If you ordered our 2725 Jet Fill Tensiometers, there should also be a Jet Fill Reservoir Cap for each unit as well.

If this is the first time you have ever ordered tensiometers from Soilmoisture, it is highly recommended that you order the 2790K1 Service Kit that is needed to service the tensiometers. (The Blue Fluid inhibits algae growth inside the tensiometer and the blue color makes it easier to see accumulated air inside the tensiometer.)

NOTE: The 2790K1 Service Kit includes a 2005G2 Vacuum Hand Pump with case, 2034 Blue Fluid Concentrate, Tensiometer Service Cap, Neoprene Tubing, Filler Bottle, and small screwdriver.

If any of your order is damaged, call the carrier immediately to report it. Keep the shipping container and all evidence to support your claim.

CAUTIONS & WARNINGS

AVOID FREEZING CONDITIONS

Tensiometers should be removed from the field prior to the onset of freezing conditions. Since a tensiometer is a water-filled system, it is essential that the unit be stored and used at temperatures above freezing. Freezing temperatures, of course, will cause the water within the unit to freeze and expand as ice is formed. This can cause breakage of the ceramic tip and distort or rupture the thin-walled Bourdon tube within the dial gauge.

If the Bourdon tube is ruptured, the dial gauge cannot be repaired and will have to be replaced. If the Bourdon tube is distorted but not ruptured, it may be possible to reset the pointer on the gauge to correct the change in calibration caused by freezing.

WARRANTY & LIABILITY

Soilmoisture Equipment Corp. (SEC) warrants all products manufactured by SEC to be free from defects in materials and workmanship under normal use and service for twelve (12) months from the date of invoice provided the section below has been met.

Soilmoisture Equipment Corp. (SEC) is not liable for any damages, actual or inferred, caused by misuse or improper handling of its products. The 2710 and 2725 Tensiometers are designed to be used solely as described in these product operating instructions by a prudent individual under normal operating conditions in applications intended for use by this product.



GENERAL SPECIFICATIONS

Specifications:

One Bar = 0.9869 Atmospheres
= 100 KiloPascals
= 750 Millimeters of Mercury
= 33.4 Feet of water
= 1020 Centimeters of water
= 14.5 Pounds per square Feet (PSI)
= 100 Centibars

The modular design allows easy replacement of the ceramic cup and dial gauge, and addition of extension tubes and the Service Cap. The tensiometer is available in a variety of lengths, ranging from 6 inches (15 cm) to 60 inches (1.5 m). Series 0240 Insertion Tools can be used for coring a hole in the soil to accept these units. The Model 2790K1 Service Kit, available separately, is used to refill and maintain the tensiometer.

LIMITATIONS:

There are 2 limitations to a tensiometer:

- The practical limit of a tensiometer is 80-85 centibars due to the effect of cavitation. Cavitation is the phenomenon where a small air bubble expands to a large air bubble due to the vacuum being created in the tensiometer.
- Another important limitation is brought on by the manometer effect of the tensiometer. The water column itself creates a vacuum on the gauge.

For every foot of a tensiometer there is 3cb of vacuum created by the water column. In a 6 foot tensiometer this amounts to 18 centibars. Soilmoisture Equipment Corp. gauges are designed so that the needle can be re-zeroed to counter this effect. This same 18 centibars must be subtracted off from the practical limit also so a 6 foot tensiometer would only be effective until about 62-67 centibars before cavitation also becomes a problem.

AQUAINT YOURSELF WITH THE PARTS

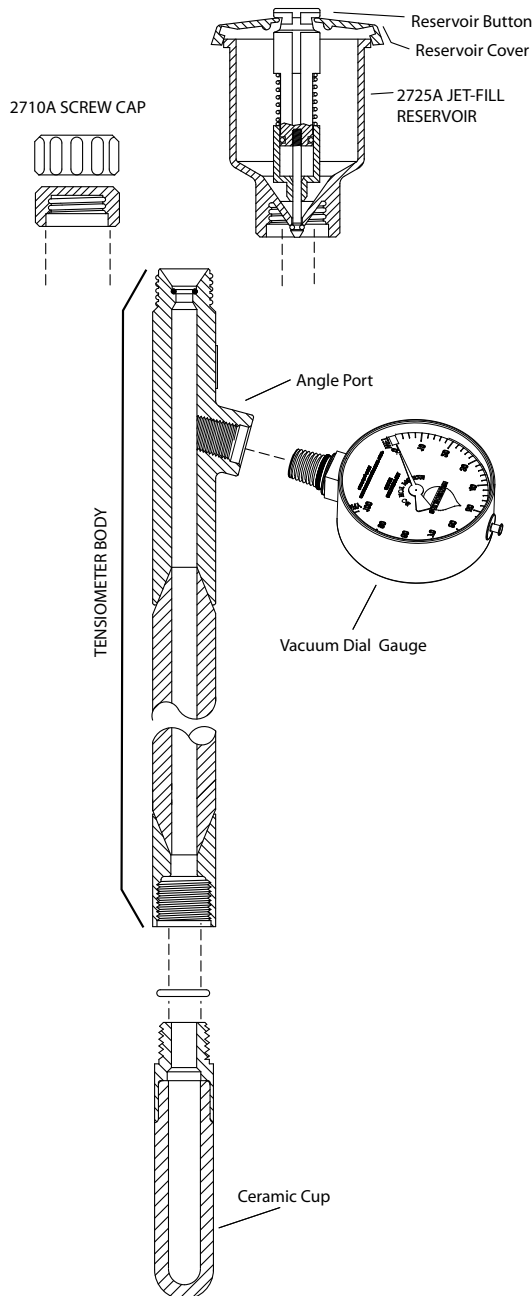

Quantity	Part #	Description
1	2060FG3	VACUUM DIAL GAUGE, RECALIBRATOR-STYLE
1	M802X111PKG05	PACK OF 5 O-RING CUP SEALS
1	Z2630A-100	TENSIOMETER CERAMIC CUP
1	Z2630A-200L##	TENSIOMETER BODY (L## SPECIFY LENGTH*)
NOTE: THE TENSIOMETER BODY IS AVAILABLE IN A VARIETY OF LENGTHS, RANGING FROM 6 INCHES (15 CM) TO 60 INCHES (1.5 M).		
1	Z2079	SCREW CAP (FOR 2710 TENSIOMETERS)
1	2075	JET FILL RESERVOIR CAP COMPLETE

* THE TENSIOMETER BODY (FOR EITHER 2710 OR 2725 STYLE) IS AVAILABLE IN A VARIETY OF LENGTHS, RANGING FROM 6 INCHES (15 CM) TO 60 INCHES (1.5M).

(Fig. 2) 2710ARL and 2725ARL Tensiometer Parts

THEORY OF OPERATION

A tensiometer measures the force with which water is held in the soil by the soil particles. This force, referred to as soil suction, tension, or potential, indicates how tightly the water is bound in the soil, and how much energy must be exerted by plant roots to remove and use the water. The basic components of a tensiometer include a porous ceramic cup, a plastic body tube, and a vacuum gauge. The ceramic cup is placed in good hydraulic contact with the soil and allows transfer of water into and out of the tensiometer body according to the tension in the soil. The vacuum inside the tensiometer body equilibrates with the soil water tension, and the dial gauge provides a direct readout of the tension.

REQUIREMENTS PRIOR TO USE / ASSEMBLY

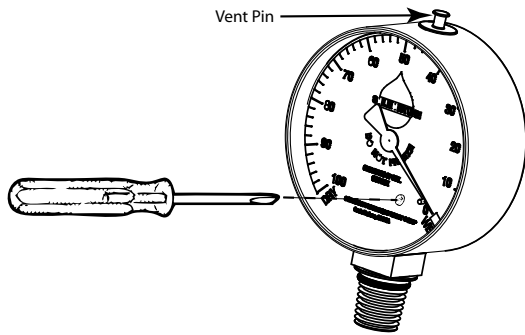

(Fig. 3) Vacuum Gauge Adjustments

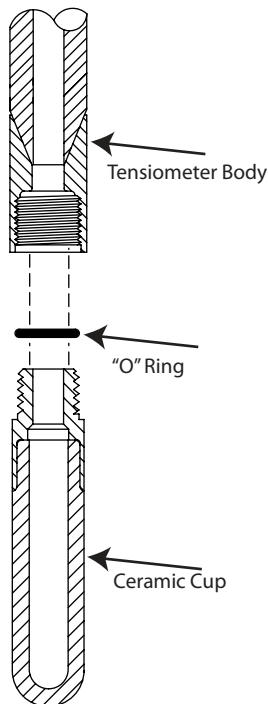

(Fig. 4) Attaching the Ceramic Tip

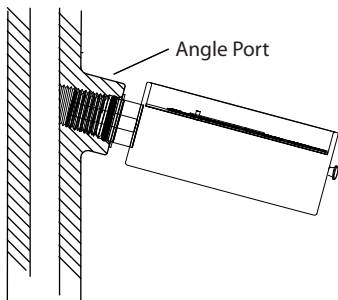

(Fig. 5) Attaching the dial gauge

ADJUSTING THE POINTER ON THE DIAL GAUGE

The tensiometer dial gauge is hermetically sealed at the factory at sea level. If you live at a higher elevation, the pointer on the dial gauge may read higher than zero when you unpack it. This is due to the lower atmospheric pressure at your elevation.

First, simply press the vent pin located at the top of the gauge to release any collected air.

Located on the face of the gauge is an insertion point for a small flathead screwdriver. If the gauge is reading high, turn the screwdriver clockwise an estimated amount to correct the error. If the gauge reads low, turn the screwdriver counterclockwise an estimated amount to correct the error. Repeat the process if necessary until the pointer is on zero.

ASSEMBLY OF THE UNIT

In order to prevent damaging your order during shipment, both the 2710 and 2725 Tensiometers are packed with the ceramic cup removed. To assemble the unit, invert the tensiometer and insert the O-ring into the threaded end of the body tube, making sure that it is seated properly in the hole. Next, screw the ceramic cup into the body tube until it makes a tight seal on the O-ring (Fig. 4). Do not over tighten. The O-ring makes the vacuum seal, not the threads. Damage to the threads will occur as a result of excessive tightening.

ATTACHING THE DIAL GAUGE

Grease O-ring with the silicone included in the 2790K1 Kit. Next, screw the dial gauge into the threaded angle port in the side of the body tube (see Fig.4). Be sure that the threads on the dial gauge stem line up properly with the threads of the angle port on the tensiometer body. Screw the dial gauge in until the backup washer on the stem touches the body tube and then unscrew dial gauge slightly until the face of the dial gauge is facing up and in the desired position for easy reading (Fig. 5). Do not over tighten the dial gauge. The O-ring on the stem of the dial gauge makes the vacuum seal, not the threads.

NOTE: The Jet Fill reservoir cap is shipped completely assembled and is easily screwed in place when you are ready to fill it with water.

REQUIREMENTS PRIOR TO USE / ASSEMBLY

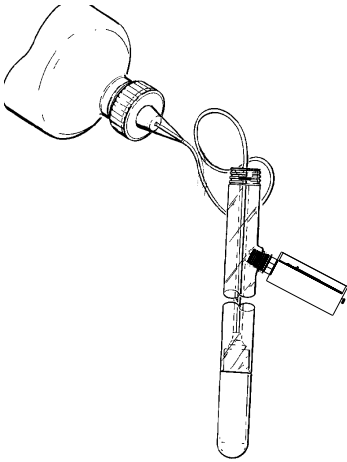

(Fig. 6) Filling the Tensiometer

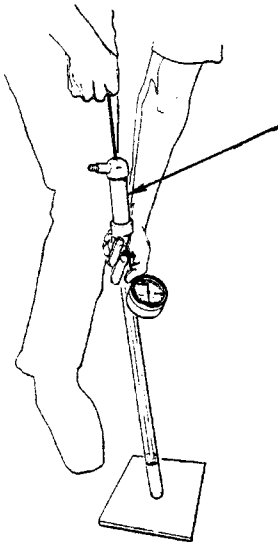

(Fig. 6a) Pulling a vacuum inside the Tensiometer using the 2005G2 Vacuum Hand Pump.

FILLING YOUR TENSIOMETER

Included with your Service Kit is a bottle of SEC Blue Fluid Concentrate (2034). This Blue Fluid inhibits algae growth inside the tensiometer and the blue color makes it easier to see accumulated air inside the tensiometer. You can also use plain water without the blue additive. Follow the instructions on the bottle to prepare the solution. We include a 16-ounce plastic filler bottle in the Service Kit to use for preparing the solution. Once the solution is ready, screw the service cap with the attached clear plastic tubing onto the filler bottle. Run the plastic tubing down to the bottom of the tensiometer. Squeeze the filler bottle and fill the tensiometer full of fluid (Fig. 6).

Keep the tensiometer in a vertical position until the ceramic cup becomes saturated and fluid drips from the ceramic tip. If you need to fill several tensiometers at once, place them together in a deep sink or empty bucket for support during the filling process. Allow the fluid to drip from the ceramic cups for about 5 minutes to be sure they are thoroughly wetted.

Next, fill the unit completely to the top and pull a vacuum inside the tensiometer using the vacuum hand pump from service kit. (Fig. 6a) With the unit held vertically, gently set the ceramic cup on a counter or board for support while the rubber end of the vacuum hand pump is held in tight contact with the O-ring cap seal of the tensiometer.

Pulling up on the pump handle creates a vacuum inside the tensiometer. You will see air bubbling out of the interior stem of the dial gauge. After each pumping, refill the tensiometer with completely to the top with water or blue fluid solution. Repeat the pumping operation four or five times until no more air bubbles from the stem of the dial gauge. When the unit is ready, seal the tensiometer by screwing the plastic Service Cap or Jet Fill Reservoir in place.

REQUIREMENTS PRIOR TO USE / ASSEMBLY

FILLING THE 2725 JET FILL TENSIO METER RESERVOIR

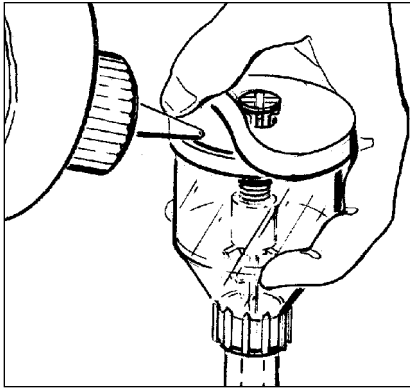

(Fig. 7a) Filling the Jet Fill Tensiometer

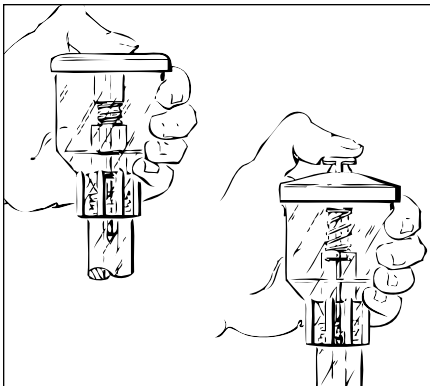

(Fig. 7b) Removing the air from the Tensiometer Body

If you have purchased the 2725 Jet Fill Tensiometer, you will also need to fill the Jet Fill Reservoir Cap. To fill the reservoir cap, peel the neoprene reservoir cover back from the top of the reservoir and fill it 3/4 full with SEC Blue Fluid Solution or water (Fig. 7a).

If you don't have a hand vacuum pump handy, you can also remove air from the dial gauge by pumping the reservoir button repeatedly after the tensiometer and reservoir have been filled (Fig. 7b). Push the button down quickly 50 to 60 times over a period of a minute or so, while observing the interior stem of the dial. Continue pumping until no more air bubbles come from the interior gauge stem. To let the air escape more easily from the gauge stem, tip the tensiometer at an angle with the dial gauge pointing down while pumping.

NOTE: If you are not able to install the tensiometer immediately after filling, cover the ceramic cup with a plastic bag to prevent evaporation of water from the ceramic cup.

HOW TO OPERATE UNIT / INSTALLATION

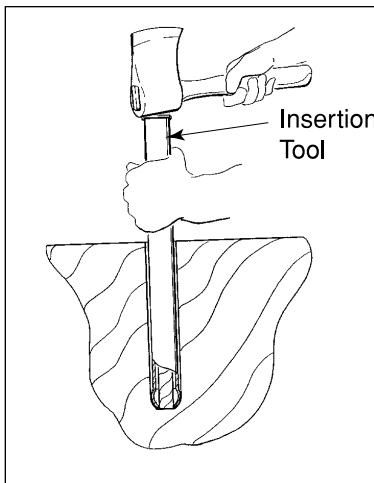

(Fig. 8a) Coring the hole

Soilmoisture tensiometers are readily installed in the soil by using conventional soil sampling tools. The body tube and porous sensing tip of the tensiometer are 7/8" (2.2 cm) in diameter. Installation must be made so that the porous ceramic cups in tight contact with the soil.

The Model 0240L54, 0240L54, 0240L78 Insertion Tools can be used in rock-free soils (Fig. 8a). Standard 1/2" (U.S.) steel pipe can also be used to drive a hole into the soil to accept the tensiometer.

Augers may also be used in rocky soils to core a larger hole. The soil is then sifted and packed around the porous ceramic cup to make good contact before the hole is back filled. The surface soil is tightly tamped around the body tube to seal surface water from entering. In difficult installations, such as in rocky soils or deep installations, a slurry of water and soil can be made up and poured into the bottom of the hole. The ceramic end of the tensiometer is then pushed into the slurry to ensure good contact between the cup and the soil. Large holes cored to

HOW TO OPERATE UNIT / INSTALLATION (cont.)

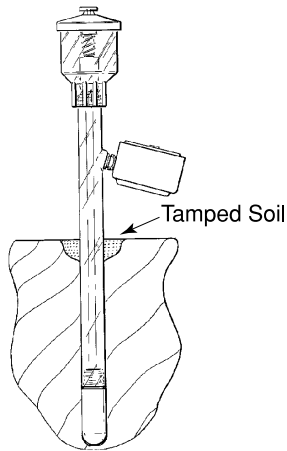

accept the tensiometer are always backfilled and the soil at the surface tamped tightly around the body tube. (Fig. 8b)

After installation, the tensiometer may require several hours before it reads the correction soil suction value. This is due to the disturbance to the soil caused by the installation procedure. The correct reading will be reached more quickly in moist soils than in dry soils.

After this initial installation period, the tensiometer will accurately indicate the soil suction value and will follow closely changes in the soil suction from hour to hour.

(Fig. 8b)

SELECT THE PROPER LENGTH SO THAT THE POROUS CERAMIC CUP WILL BE IN THE ACTIVE ROOT ZONE.

FOR SHALLOW ROOTED PLANTS (Fig. 9a)

For plants with shallow root systems of less than 18" in depths, such as certain row crops, a single tensiometer with porous ceramic cup located 3/4 of the way down the root zone can give adequate information. The tensiometer cup can be located near the surface when the plant is young and then lowered as the root system develops.

FOR DEEP ROOTED PLANTS (Fig. 9b)

For plants and trees with large root systems it is necessary to use two Soilmoisture Tensiometers at each selected station, as shown in (Fig. 9b) to the right. One shallow unit is placed with tip approximately one-quarter of the way down the root zone. One deep unit is placed with cup approximately three-quarters of the way down into the root zone.

In an orchard with an average root system, the shallow unit would be at 12" to 18" in depth and the deep unit would be at 24" to 36" in depth. By using two Soilmoisture Tensiometers at a station, the grower knows the moisture condition throughout the active root zone. When the shallow unit indicates high soil suction values, irrigation is started. Irrigation is continued until the reading on the deep unit drops – indicating that the irrigation water has penetrated to that depth and the whole active root zone has been re-wetted.

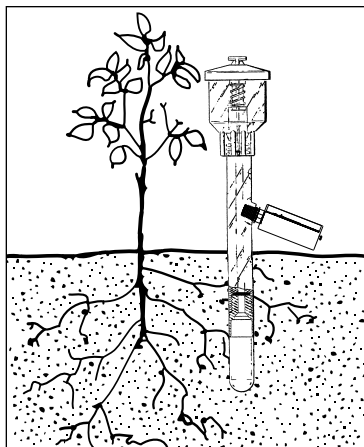

(Fig. 9a)

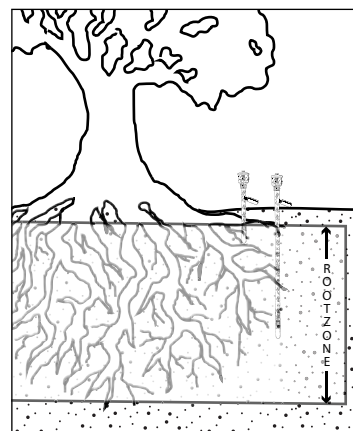

(Fig. 9b)

TENSIOMETER LOCATION PLACEMENT FOR IRRIGATION CONTROL

Install the Soilmoisture Tensiometer by inserting the body of the Tensiometer into a hole made by a length of standard pipe / rod or by a soil sampling tube. Make sure that the porous cup of the Tensiometer is in good contact with the soil. Lightly tamp the surface soil around the Tensiometer body to make a good seal.

LOCATION OF STATION

“Tensiometer station” is the name given to a tensiometer installation consisting of one or more tensiometers at one place. To monitor moisture conditions in the field, tensiometer stations are located in critical places, required by the irrigation system. Careful selection of a Soilmoisture Tensiometer station is important. The following factors should be kept in mind in selecting a station.

RELATIONSHIP TO PLANTS

- For row crops, locate the Soilmoisture Tensiometer station directly in the row.
- For orchards, locate the station at the drip line of a tree on the tree side of the first furrow, preferably on the south or west side.
- If sprinkler irrigation is used, it is important to locate the Soilmoisture Tensiometers to make sure they are not shielded by a low hanging branch or flooded by runoff.

TYPE OF SOIL

Rates of penetration and storage capacity vary greatly between different soil types. Therefore, the Soilmoisture Tensiometer installation should be made where the soil is most representative of the field to be irrigated. Additional stations should be located where soil type is radically different in order to provide information on proper irrigation timing for those different areas. In large level fields of uniform deep soil that are subject to uniform irrigation practice, a single Tensiometer station may serve as a guide for several acres.

TOPOGRAPHY

On hilly fields place Soilmoisture Tensiometer stations at the high and low areas where drainage conditions may be different. By placing Tensiometer stations in the most productive area of an irrigated plot observations can be made about the moisture conditions in each area. Then changes in irrigation practice can be made so moisture conditions in the unproductive area match those of the productive area.

IRRIGATION LAYOUT

Where furrow or basin irrigation is practiced, place one Tensiometer station near the upper end and one near the lower end of long runs so the head of water and timing can be adjusted to make the distribution as uniform as possible.

WHEN TO IRRIGATE

In general, if soil suction values are kept below 70 centibars in the active root zone (reading of 70 on Bourdon dial type gauges or 700 on manometer type units) well established plants will not suffer from lack of water. In sandy soils where water storage capacity is small, it is best to start irrigation at lower readings especially if a delay in the irrigation procedure is likely.

If Soilmoisture Tensiometer readings remain at 0-10 centibars for days at a time, this indicates a harmful saturated condition. Steps should be taken to withhold irrigation water and/or improve drainage. It is very useful to plot Soilmoisture Tensiometer readings on a graph during the growing season. In particular, the rate of increase in soil suction that is shown on the graph indicates when irrigation will be required.



GENERAL CARE AND MAINTENANCE/MINOR ADJUSTMENTS

SERVICING YOUR TENSIOMETERS IN THE FIELD

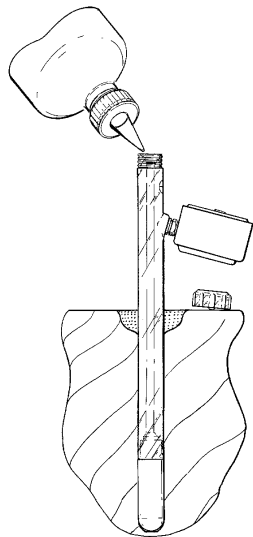

(Fig. 10)

SEC tensiometers are weatherproof and require little servicing other than occasionally refilling the tensiometer with solution using the filler bottle from your Service Kit or by pumping the button on the Jet Fill Reservoir Cap to remove accumulated air within the tensiometer.

If the soil in which the tensiometer has been installed is moist and the soil suction readings are low, very little air will accumulate in the body tube of the tensiometer. If, however, the tensiometer has been installed in relatively dry soil and soil suction values are in the range of 40 to 60 centibars, air will accumulate rather quickly for the first few days after installation. This initial accumulation of air is due to air coming out of solution and detaching itself from the internal walls of the tensiometer when exposed to high vacuum for the first time.

After initial installation, check the tensiometer every day or two and remove accumulated air from the 2725 Jet Fill Tensiometer by pushing the Jet Fill Reservoir Button or refilling the 2710 Style Tensiometer with solution (Fig. 10). The 2710 Tensiometer should be refilled when the water level inside the tensiometer is 1/2-inch to 1-inch or more below the Service Cap.

After the first few air removal servicing operations using the vacuum hand pump in the field, the rate of air accumulation will drop off markedly, and air removal servicing will then be required only on a weekly or longer basis.

ADJUSTING THE POINTER ON THE DIAL GAUGE (Fig. 11)

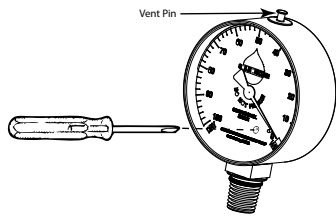

(Fig. 11) Vacuum Gauge Adjustments

First, simply press the vent pin located at the top of the gauge to release any collected air.

Located on the face of the gauge is an insertion point for a small flathead screwdriver. If the gauge is reading high, turn the screwdriver clockwise an estimated amount to correct the error. If the gauge reads low, turn the screwdriver counterclockwise an estimated amount to correct the error. Repeat the process if necessary until the pointer is on zero.

REPLACEMENT PARTS LIST

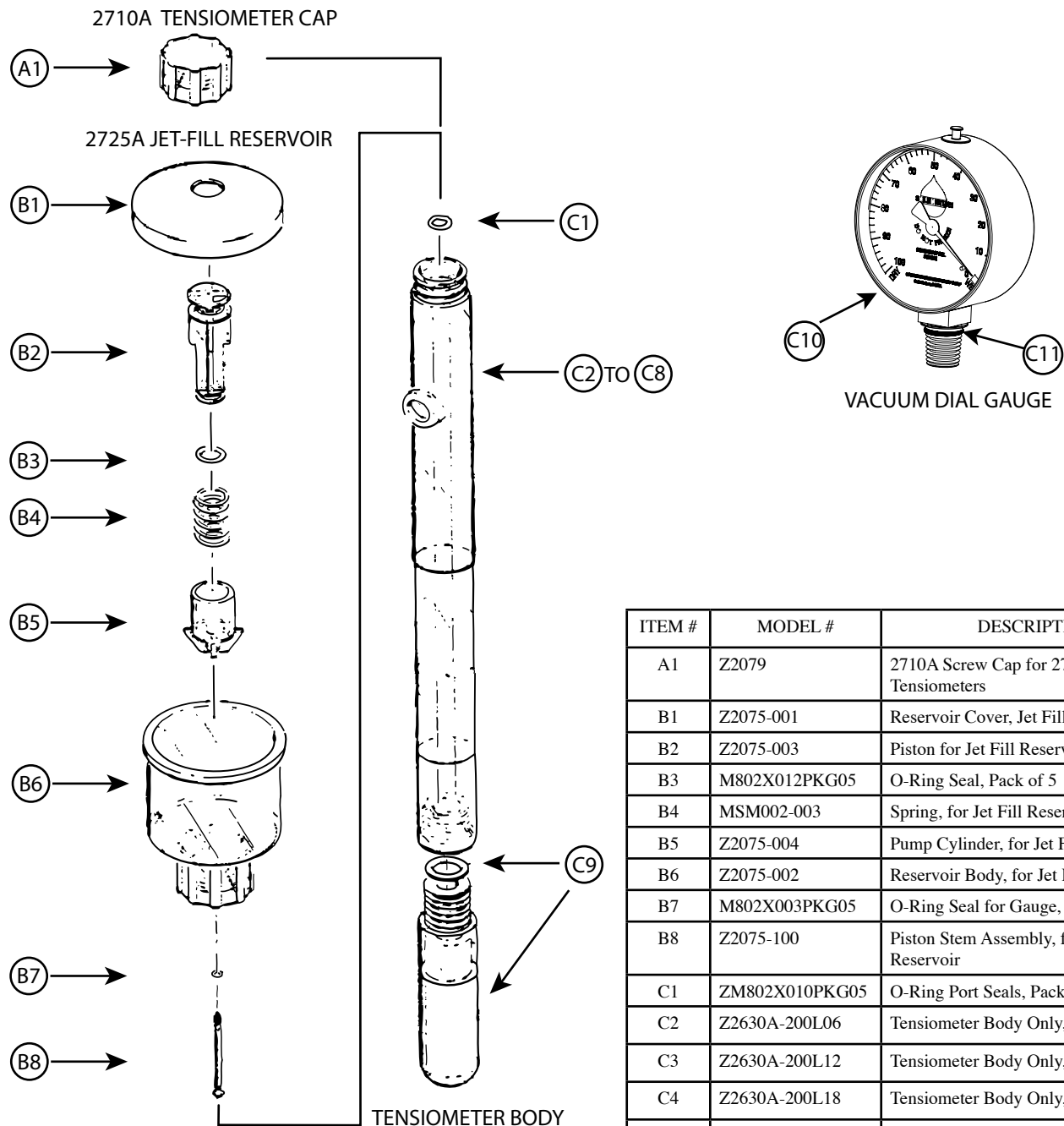

ITEM #	MODEL #	DESCRIPTION
A1	Z2079	2710A Screw Cap for 2710 Tensiometers
B1	Z2075-001	Reservoir Cover, Jet Fill Reservoir
B2	Z2075-003	Piston for Jet Fill Reservoir
B3	M802X012PKG05	O-Ring Seal, Pack of 5
B4	MSM002-003	Spring, for Jet Fill Reservoir
B5	Z2075-004	Pump Cylinder, for Jet Fill Reservoir
B6	Z2075-002	Reservoir Body, for Jet Fill Reservoir
B7	M802X003PKG05	O-Ring Seal for Gauge, pack of 5
B8	Z2075-100	Piston Stem Assembly, for Jet Fill Reservoir
C1	ZM802X010PKG05	O-Ring Port Seals, Pack of 5
C2	Z2630A-200L06	Tensiometer Body Only, 6 inch length
C3	Z2630A-200L12	Tensiometer Body Only, 12 inch length
C4	Z2630A-200L18	Tensiometer Body Only, 18 inch length
C5	Z2630A-200L24	Tensiometer Body Only, 24 inch length
C6	Z2630A-200L36	Tensiometer Body Only, 36 inch length
C7	Z2630A-200L48	Tensiometer Body Only, 48 inch length
C8	Z2630A-200L60	Tensiometer Body Only, 60 inch length
C9	Z2630-100K1	Tensiometer Screw Top Cup, with O-Ring Seal
C10	2060FG3	Vacuum Dial Gauge, Recalibrator Style
C11	M802X013PKG05	O-ring seal for Gauge, Pack of 5

OTHER USEFUL ITEMS

Part No.	Name
Z2029	Gauge Adjusting Screwdriver
Z2710-001	Service Cap with Nipple
2790K1	Service Kit - Comes with 2005G2 Hand Pump, Charts and Algaecide
2790U1	Tensiometer Filling Fixture
0234LOMBD04	Edelman Auger, 4 cm Diameter, Bayonet Connection
0234SHDLB	Auger Handle, Detachable Grip, Bayonet Connection, 60 cm long
0234NHDLB	Auger T-Handle, Bayonet Connection, 60 cm length
0234HAMR	Dead Blow Hammer
0234SHDLLBXL100	Auger Extension Rod, Bayonet Connection, 100 cm
1907	Sieve Kit
MFJ012PK	¼ Oz. Silicone Grease Kit
2720L06	Tensiometer Extension Tube, 6 inch
2720L12	Tensiometer Extension Tube, 12 inch
2720L18	Tensiometer Extension Tube, 18 inch
2720L24	Tensiometer Extension Tube, 24 inch
2720L36	Tensiometer Extension Tube, 36 inch
2720L48	Tensiometer Extension Tube, 48 inch
2720L60	Tensiometer Extension Tube, 60 inch
Z2710K2	2710 "O" Ring Kit
Z2725K1	2725 "O" Ring Kit
5301-B1	4-20 mA Transducer, Zero to -1 Bar
5301-B.5	4-20 mA Transducer, Zero to -0.5 Bar
5301-B.5	4-20 Ma Transducer
5302	0-100 mV Tranducer
Z2630A-100-B0.5M2	Half Bar Ceramic Screw Top Cup For Tensiometers

**With dealers throughout the world,
you have convenience of purchase and assurance
of after-sales service.**

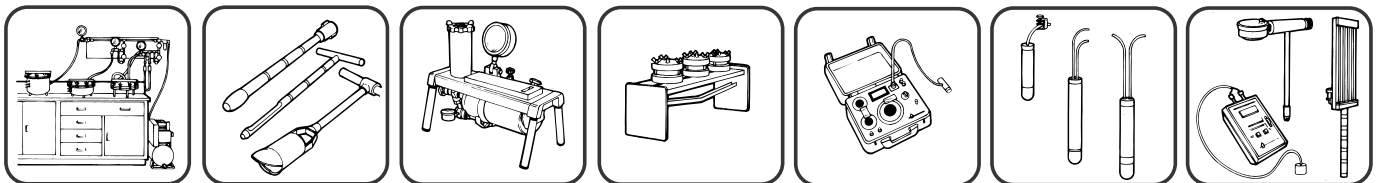

© COPYRIGHT 2011 ALL RIGHTS RESERVED 0898-2710/2725