

LAQUA Twin Nitrate NO_3^- Meter

PRODUCT MANUAL

Item 2305GL



Spectrum[®]
Technologies, Inc.

CONTENTS

Introduction	3
Quick Operation Guide	4
Meter Components and Functions	6
Handling Precautions	8
Calibrating Solutions	10
Calibration	11
Measurement Procedure	14
Setting Special Modes	16
Replacing the Sensor	21
Installing and Replacing Batteries	22
Preparing Soil Samples	23
Collecting Tissue Sap	25
Preparing Soil-less Media	26
Specifications	28
Soil Test Kit Accessories	29
Sufficiency Levels	30
Frequently Asked Questions	38
Warranty	39

This manual will familiarize you with the features and operation of your LAQUA Nitrate meter. Please read this manual thoroughly before using your meter. For customer support or to place an order, contact Spectrum Technologies, Inc between 7:30 a.m. and 5:30 p.m. CST.

Phone: (800) 248-8873 or (815) 436-4440

Fax: (815) 436-4460

E-mail: info@specmeters.com.

Website: www.specmeters.com

INTRODUCTION

Congratulations on the purchase of your LAQUA Twin Nitrate (NO_3^-) meter. This manual describes how to use your LAQUA meter and how to keep it working accurately for many years. Read it thoroughly in order to make effective use of your meter.

Nitrogen is one of the most important elements required for plant growth. It is a key component in chlorophyll, the pigment in plants that harnesses the sun's energy to convert CO_2 into carbohydrates and makes plants green. Tools that provide increased management of N offer significant economic benefits to plant growers of all types. In addition, applying just the right amount of nitrogen at the right time can help safeguard the environment by reducing the amount of residual soil nitrate (NO_3^-) available to leach into ground water.

This self-contained, waterproof, digital meter delivers high quality answers to nitrate level questions in soils, plants, and water-based solutions. The replaceable pen-type sensor makes the measurement of small samples much more convenient. When replacement of the sensor is required, the sensor cartridge snaps in and out of the meter at a touch.

The readout of the measurement value is an LCD display. It has a total display range of 14 - 1400 ppm NO_3^- -N. The display can be set to readout in units of nitrate (NO_3^-) or nitrate-nitrogen (NO_3^- -N).

Quick Operation Guide

This quick operation guide introduces the basic operations.
Refer to the respective chapters for further information.

① Turn ON

Press the ON/OFF button over 2 seconds to turn ON the meter.

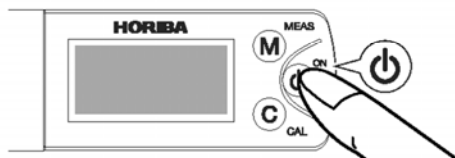

② Calibration

Perform calibration at least once a day for accurate measurement.

① Pour the 2000 ppm standard solution. ② Close the light shield cover.

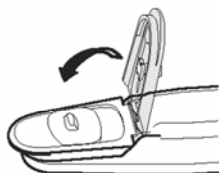

③ Press the CAL button over 2 seconds.
When **CAL** and ☺ light up, the calibration is completed.



④ Clean the sensor with water.



⑤ Press the MEAS button to enter the measurement mode.



③ Measurement

① Pour some drops of sample.



② Close the light shield cover.

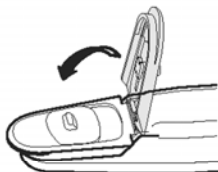

③ When ☺ lights up, the measurement is completed.
To lock the measured value, press the MEAS button.



④ After Use

Clean the sensor with water,
and then turn OFF the power.
Close the light shield cover before storage.
Make sure to store the sensor without any moisture.



The following settings can be changed.

- Measurement unit · Calibration mode
- Temperature/sensor voltage display
- Multiplying/adding compensation · Calibration value

Two-point calibration is recommended for accurate measurement.
Prewashing the sensor with the sample may provide accurate measurement.

METER COMPONENTS AND FUNCTIONS

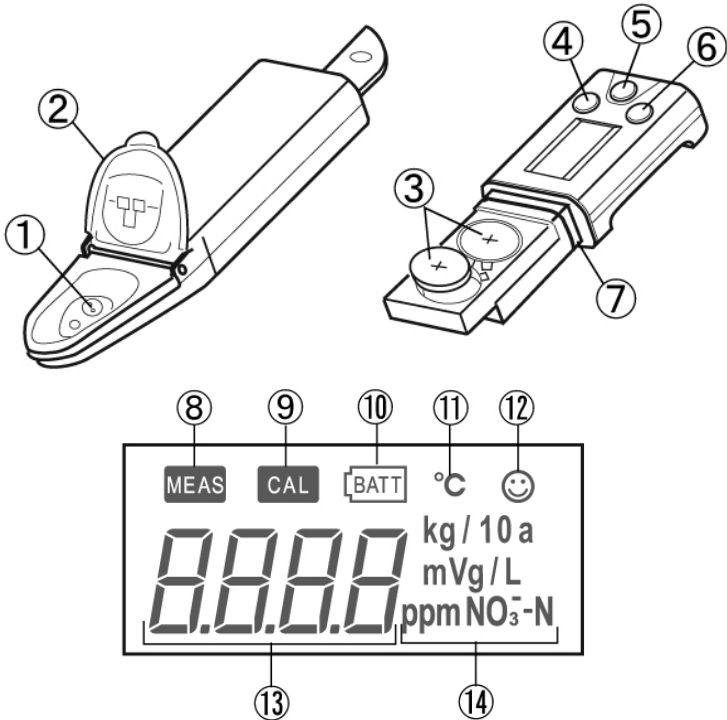

No.	Name	Description
1	Flat sensor	Consists of a liquid junction (electrode A) and response membrane (electrode B). Both electrodes must be covered by sample to enable accurate measurement.
2	Light shield cover	Cover used to shield sensor from light. Because the sensor is affected by light, attach the light shield cover before starting measurement.
3	Lithium batteries	CR2032

No.	Name	Description
4	MEAS button	Used during measurement. Press the button for ½ second to evaluate the stability of the measured value. The screen will lock onto a stable value. If this button is pressed for 5 seconds, the meter will go into the special setting mode (p. 16)
5	ON/OFF button	Press and hold for at least 2 seconds to turn meter ON or OFF.
6	CAL button	Press and hold for at least 2 seconds to calibrate the meter.
7	Waterproofing gasket	Provides waterproof seal for meter.
8	MEAS icon	Flashes during calibration and lights steadily when meter locks onto a measurement.
9	CAL icon	Flashes during measurement and lights steadily when calibration is finished.
10	Battery alarm icon	Lights when batteries are low in power and need to be replaced.
11	Temperature alarm icon	Flashes when the measuring environment temperature is out of range (not between 5° and 40°C).
12	Stability icon	Lights only when the measured value has stabilized.
13	Display	Flashes when the measurement is out of range. When Hi is displayed, the result is too high. Dilute the sample and take measurement again.
14	Measurement unit display	The default setting is “NO ₃ ”. See “Special Setting Modes” (p. 16) for instructions to change modes.

HANDLING PRECAUTIONS

Meter and Sensor

- The sensor is a consumable part. If it becomes damaged or its performance deteriorates, it must be replaced.
- Do not swing the meter and sensor by holding the strap.
- To ensure a waterproof seal, confirm the following when attaching the sensor.
 - The waterproofing gasket is clean and undamaged.
 - The gasket is seated properly in the groove with no twisting and warping.
 - The meter and sensor are not deformed.
- Neither the meter nor sensor is waterproof by itself. The sensor must be securely mounted on the meter before use.
- Never drop the meter or apply excessive force to it.

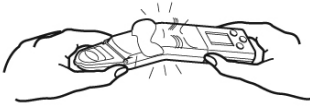

- Do not leave the meter in areas of direct sunlight or high temperature/humidity



- Do not clean the meter with organic solvents.

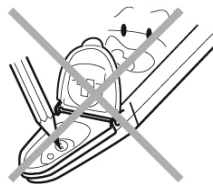

- Store the response membrane of the flat sensor in dry condition. If the response membrane gets wet for extended time periods, it may become deformed.
- Measurement of organic solvents, oils, adhesives, cement, alcohols or concentrated acids ($\text{pH} < 2$) as well as concentrated alkalines or surfactants ($\text{pH} > 12$) will shorten the sensor's life.
- When using the meter for the first time, or after several weeks of inactivity, the sensor may be slow to respond. Put some reference solution on the sensor and wait 10 to 60 minutes before switching the meter on.
- Some sample types (such as oily plant sap) may not yield stable values.
- White powder may appear on sensor electrode A (the liquid junction) when using the meter in low-humidity environments. Liquid may appear on the electrode in high humidity environments. The appearance of powder or liquid is normal. Simply wash it off with water before using the meter.

Batteries

- The batteries provided with the meter are for monitoring and may have a short life.
- When replacing batteries, replace both at once.
- Never dispose of batteries in an open flame or attempt to recharge them. Keep used batteries out of reach of children.
- Replace the batteries when the low voltage alarm icon illuminates. When the voltage is low, you may not be able to turn the meter on.

Safety

- Wash off any calibration solution that comes into contact with hands or exposed skin. If fluid gets in the eyes, rinse them immediately and see a doctor.
- Sensor B is made of PVC. Because the PVC's plasticizer may seep into the fluid being measured, never drink any fluid that has come in contact with the sensor.

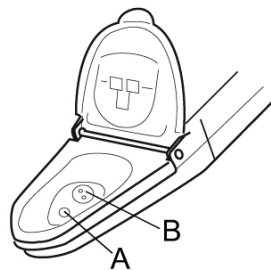

CALIBRATING SOLUTIONS

NO_3^- (nitrate) versus NO_3^- -N (nitrate-nitrogen)

The sensor of the LAQUA meter measures NO_3^- nitrate ion activity similar to the way a pH sensor measures H^+ ion activity. Decide whether you desire the meter LCD display to express the sample concentration as NO_3^- nitrate or NO_3^- -N nitrate-nitrogen. (Note: this is similar to referencing length as 6 in. or ½ ft.). Laboratory analysis and university guidelines are generally expressed as NO_3^- -N nitrate-nitrogen.

To convert NO_3^- -N nitrate-nitrogen to NO_3^- nitrate:

$$\begin{array}{ccc} \text{multiply} & \text{or} & \text{divide} \\ \text{NO}_3^- \text{-N} \times 4.42 = \text{NO}_3^- & & \text{NO}_3^- \text{-N} / .226 = \text{NO}_3^- \end{array}$$

Therefore:

$$\begin{array}{l} 2000 \text{ ppm } \text{NO}_3^- \text{ nitrate} = 450 \text{ ppm } \text{NO}_3^- \text{-N nitrate-nitrogen} \\ 150 \text{ ppm } \text{NO}_3^- \text{ nitrate} = 34 \text{ ppm } \text{NO}_3^- \text{-N nitrate-nitrogen} \end{array}$$

The following table shows the concentrations of the various calibration standards in each unit of measurement.

Description	ppm NO_3^- -N	ppm NO_3^-
#2311 450 ppm NO_3^- -N *	2000	450
#2312 34 ppm NO_3^- -N *	150	34
#2336 450 ppm NO_3^- -N **	2000	450
#2334L 34 ppm NO_3^- -N **	150	34

* For use with plant sap, water and nutrient solutions.

** For use with soil samples (contains aluminum sulfate).

CALIBRATION

Selecting 2-Point Calibration Mode.

The meter is shipped with the meter in the 1-point, high-concentration (Hi.1) calibration mode. A 2-point calibration is recommended if the concentrations of the samples differ by more than 10-fold. The calibration mode can be changed as follows (see also “Setting Special Modes”, p. 16).

1. With the meter on, press and hold the **MEAS** button for at least 5 seconds to enter the special setting mode. When all the LCD elements illuminate, release the **MEAS** button and all possible measurement units appear.

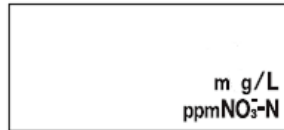

If the button is held too long, the LCD will display the word “Unit”. In this case, press and hold the **MEAS** button to get back into measurement mode and repeat this step.

2. Press and hold the **CAL** button until the **CAL** icon appears. If you pass this mode, press and hold the **CAL** button until it cycles around to the proper screen.

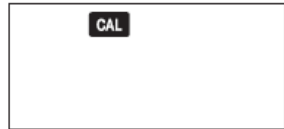

3. Press the **MEAS** button to displays the current calibration mode (Hi.1, Lo.1, or 2). Press the **CAL** button until the number 2 is displayed. This will put the meter in 2-point calibration mode.



4. Press the **MEAS** button to save the calibration mode. The meter will return to standard measurement mode.

Two-Point Calibration (ppm NO_3^- - N mode)

1. Press and hold the ON/OFF button for, at least, two seconds to power the unit on.



2. Add enough of the 34 ppm NO_3^- -N reference solution to cover the space between electrodes A and B. Close the light shield cover and press the **CAL** button until the **CAL** icon flashes (a minimum of 2 seconds).

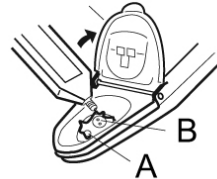

3. When the first calibration has been finalized, the **CAL** icon will stop flashing. The first calibration must be finalized before proceeding to the second calibration.

4. Repeat step 2 with the 450 ppm NO_3^- -N reference solution.

5. When the second calibration has been finalized, the **CAL** icon will stop flashing and the reference solution concentration will be displayed. The meter has not properly calibrated if the **CAL** icon remains flashing or if “ERR” is displayed on the LCD. In this case, confirm you have used the correct calibration solution, wash the sensor thoroughly and try to re-calibrate the sensor.

If the two calibrations fail but the displayed reference solution concentration is correct, the sensor should be replaced.

6. Wash the sensor with tap water and remove any adhering droplets before taking measurements.

7. Press the **MEAS** button to return to measurement mode.

One-Point Calibration (ppm NO₃⁻ - N mode)

A one point calibration can be performed with either the High (450 ppm NO₃⁻ - N) or Low (34 ppm NO₃⁻ - N) calibration solution. This is selected in the Special Settings Mode 3 (p. 18)

1. Press and hold the ON/OFF button for, at least, two seconds to power the unit on.

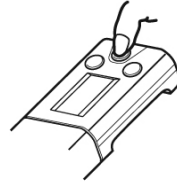

2. Open the light shield cover and add enough of the reference solution to cover the space between electrodes A and B. Rinsing the sensor pad with reference solution beforehand will increase the accuracy of the calibration.

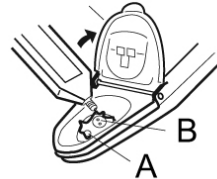

3. Close the light shield cover and press the **CAL** button until the **CAL** icon flashes (a minimum of 2 seconds).

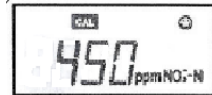

4. When the calibration has been finalized, the **CAL** icon will stop flashing. The reference solution concentration will be displayed along with the icon. The meter has not properly calibrated if the **CAL** icon remains flashing or if the **ERR** symbol is displayed on the LCD. In this case, confirm you have used the correct calibration solution, wash the sensor thoroughly and try to re-calibrate the sensor.

5. Wash the sensor with tap water and remove any adhering droplets before taking measurements.

6. Press the **MEAS** button to return to measurement mode.

MEASUREMENT PROCEDURE

Measurement on a flat surface

Important: Do not make measurements with the meter (sensor) in direct sunlight.

1. Open the light shield cover and add enough of the sample to cover the space between electrodes A and B.

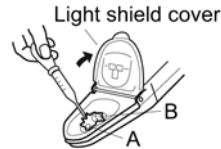

2. Close the light shield cover



3. When the stability icon ☺ appears, the LCD will display the current nitrate concentration. To lock in a reading, press the **MEAS** button. The **MEAS** icon will flash to indicate that measurement has begun.



4. When the measurement is complete, the **MEAS** icon will cease flashing and the displayed value will be locked.

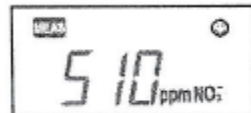

5. Press the **MEAS** button again to unlock the LCD and return to dynamic reading mode. After rinsing the sensor, steps 1 - 4 can then be repeated.

*Measurements can be made without pressing the **MEAS** button. In this case, the meter will remain in dynamic measurement mode.*

Submerged Measurement

1. Open the light shield cover's sliding cap. Submerge the sensor in the sample and shake it gently 2 or 3 times.
2. When the stability icon ☺ appears, proceed as with flat surface measurements (p. 14).

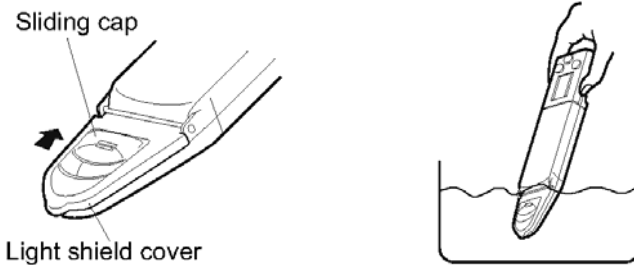

Scoop Measurement

1. Open the light shield cover's sliding cap. Submerge the sensor in the sample and shake it gently 2 or 3 times. Scoop up some of the sample onto the meter. Place the meter on a flat surface.
2. When the stability icon ☺ appears, proceed as with flat surface measurements (p. 14).

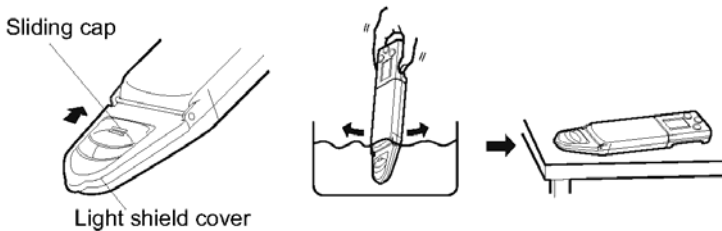

Temperature Measurement

The meter has an internal temperature sensor. A reading can be taken in special settings mode 2 (see p. 17).

SETTING SPECIAL MODES

The LAQUA nitrate meter has 9 special modes that can be modified at the user's discretion. The modes are:

- | | |
|-----------------------------|----------------------------|
| 1. Set measurement units | 2. Temperature measurement |
| 3. Set # of calibrations | 4. Set slope coefficient |
| 5. Set offset coefficient | 6. Voltage measurement |
| 7. Low Calibration Value | 8. Initialization Mode |
| 9. Software Version Display | |

Entering Special Setting Mode

Press and hold the **MEAS** button for, at least, 5 seconds while the meter is in measurement mode. Release the **MEAS** button as soon as you see all the LCD elements illuminated.



Full display screen

The LCD will then transition to special setting mode starting with the screen for mode 1. If the **MEAS** button is not released immediately after seeing the full display, the meter will enter the "Set measurement units" mode and display the word "Unit".

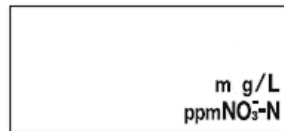

Sample mode selection screen

In this case, press and hold the **MEAS** button to return to measurement mode and start over.

To scroll to the next mode, press the **CAL** button for half a second. If the **CAL** button is held down, the meter will cycle through the modes sequentially.

Once in the desired mode selection screen, press and hold the **MEAS** button for half a second to modify that configuration. Pressing and holding the **MEAS** button will take you out of special setting mode. See the following pages for details on each mode.

Mode 1 (Set measurement units)

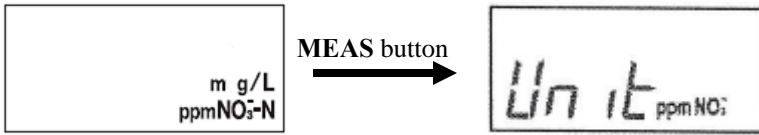

From mode selection screen 1, press the **MEAS** button for half a second. From here, you can configure which units will be displayed. Press the **CAL** button for half a second to cycle to the desired option. The choices are:

ppm NO₃⁻ - N, ppm NO₃⁻, mg/L NO₃⁻ - N, and mg/L NO₃⁻

Press and hold the **MEAS** button to return to measurement mode.

Mode 2 (Temperature measurement)

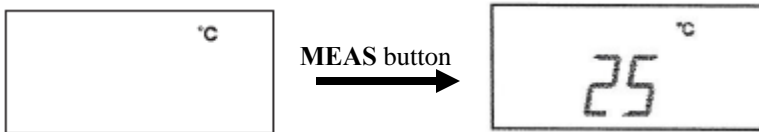

From mode selection screen 2, press the **MEAS** button for half a second. This is not a mode configuration screen. Instead, in this mode, the meter displays the reading of the internal temperature sensor (in Celsius). The measurement precision is not guaranteed and should only be used as an estimate.

Press and hold the **MEAS** button to return to measurement mode.

Mode 3 (Set number of calibrations)

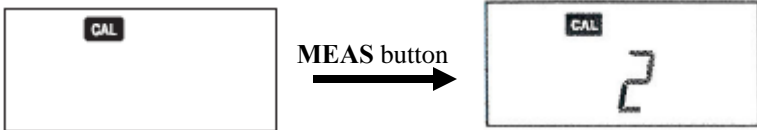

From mode selection screen 3, press the **MEAS** button for half a second. From here, you can configure the number of solutions that will be used to calibrate the meter. The options are:

Hi.1 One-point calibration at the High concentration level (450 ppm NO_3^- - N)

Lo.1 One-point calibration at the Low concentration level (34 ppm NO_3^- - N)

2 Two-point calibration (both concentration levels)

Press the **CAL** button for half a second to cycle to the desired option.

Press and hold the **MEAS** button to return to measurement mode.

Mode 4 (Set slope coefficient)

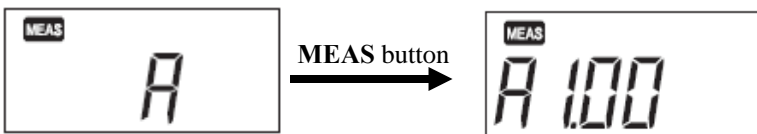

From mode selection screen 4, press the **MEAS** button for half a second. By pressing the **CAL** button, you can set a multiplicative constant (0.01 to 9.90) that will be multiplied by the reading. This, along with the offset setting (mode 5), can be used to modify the output value to suit a specific application such as dilute or concentrated solutions. The default setting is 1.00.

Press and hold the **MEAS** button to return to measurement mode.

Mode 5 (Set offset coefficient)

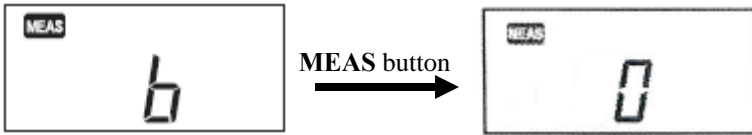

From mode selection screen 5, press the **MEAS** button for half a second. By pressing the **CAL** button, you can set an additive constant (-1000 to 1000) that will be added to the reading. This, along with the slope setting (mode 4), can be used to modify the output value to suit a specific application such as dilute or concentrated solutions. The default setting is 0.

Press and hold the **MEAS** button to return to measurement mode.

Mode 6 (Sensor voltage measurement)

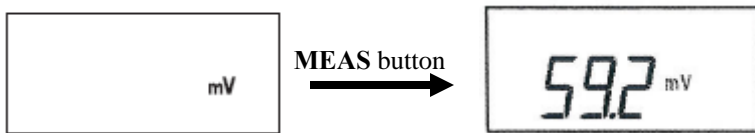

From mode selection screen 6, press the **MEAS** button for half a second. This is not a mode configuration screen. Instead, in this mode, the meter displays the reading of the sensor voltage (in mV). Use this mode to evaluate sensor performance or to create your own calibration curve.

Press and hold the **MEAS** button to return to measurement mode.

Mode 7 (Low calibration value setting)

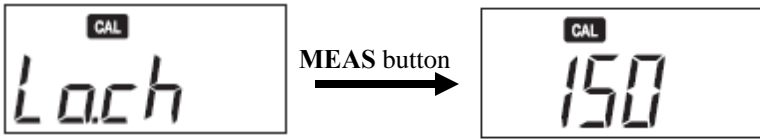

From mode selection screen 7, press the **MEAS** button for half a second. The current low concentration value will be displayed. The default value is 150 (units are ppm NO₃⁻). By pressing the **CAL** button, you can increment this value up to 1990. After reaching 1990, the value will drop down to 62 and then continue to increment up as long as the **CAL** button is pressed. Press and hold the **MEAS** button to return to measurement mode.

Mode 8 (Initialization mode)

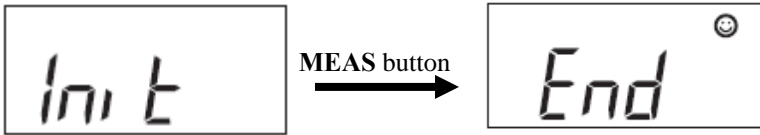

From mode selection screen 8, press the **MEAS** button for half a second to enter Initialization mode. This allows you to reset the meter to factory settings. Press and hold the **CAL** button for over 2 seconds. The meter will display the **End** screen when initialization is complete. Press and hold the **MEAS** button to return to measurement mode.

Mode 9 (Software version)

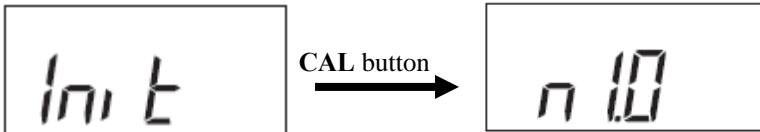

If the **CAL** button is pressed while in mode selection screen 8 (see above), the LCD will display the software version of the meter. Press and hold the **MEAS** button to return to measurement mode.

REPLACING THE SENSOR

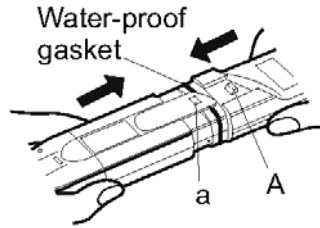
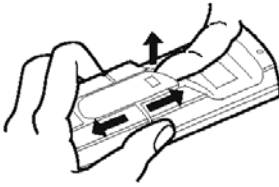

Removal

Lift hole **a** off tab **A** and slide the sensor away from the chassis.

Replacement

Slide the sensor onto the body so that tab **A** fits into hole **a**. Take care not to twist the waterproof gasket.

Precautions

- Be sure the meter is off before removing or replacing the sensor.
- As shown here, make sure that the sensor tab is inserted over the copper strip on the main unit. Be careful not to damage the connector.
- When removing the sensor, carefully wipe off any drops of sample remaining on the water proof gasket. Do not let water permeate the main body.

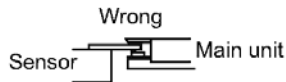
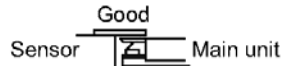
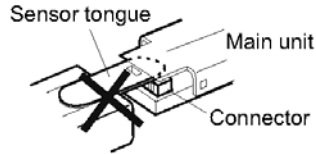

INSTALLING AND REPLACING BATTERIES

Installation

Slide both batteries into the battery clips as shown such that the positive sides are facing upward.

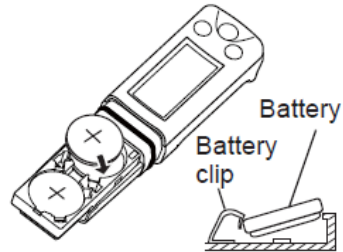

Replacement

Turn off meter. Use a small flat-head screwdriver or other instrument to pry the batteries from the clips as shown. Always replace both batteries at once.

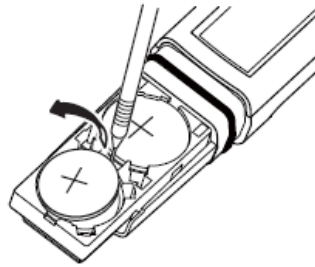

PREPARING SOIL SAMPLES

Sample Collection

Collect at least 15 to 20 core samples from an area not exceeding ten acres by using a Z pattern. Areas having different soil types or management histories should be sampled separately. Sample the top 12 inches of soil. Some universities recommend sampling the top 24 inches in 12 inch increments. Contact your county extension agent for recommendations. Care should be taken to ensure that soil samples are not biased by the presence of rows or bands of fertilizer.

Soil Preparation

Samples should be dried within 24 hours of collection to minimize changes in NO_3^- -N concentrations. Before drying, crumble the soil to avoid large clods that will be difficult to crush when dry. The samples should then be dried by spreading on a thin layer of newspaper at least 3 pages thick and placing overnight in a warm spot with good air movement. Soil will dry in a few hours if placed in a sunny location exposed to the wind. If dried indoors, 24 to 48 hours may be required. Indoor drying time can be reduced with the use of a fan. For oven drying, spread a thin layer of soil on a cookie sheet or pie plate. Place it in an oven set to no more than 250°F with the door slightly ajar. Consider the soil dry when it crumbles rather than compacts under pressure. After drying, crush the soil by using a block of wood or other suitable device. Crush until the soil particles are the size of BB's or smaller. Sift with a flour sifter or other 10 mesh screen. Mix soil thoroughly.

Soil testing of mineral soil requires the Soil Test Kit (item #2330). Be sure you are using the soil standard solutions (item nos. 2334L and 2336) when calibrating the meter for soil tests. Do not use the calibration standards for water/plant sap (See **Calibrating Solutions**, p. 10).

Sample Preparation

1. Measure 2 level measuring spoons (30 ml) full of dry soil into the soil sample cup.
2. Add 2 (30 ml) measuring spoons of the soil extractant to the soil.
3. Mix the soil and the solution by stirring with the spoon for at least 2 minutes, making sure the soil sample is thoroughly mixed. Let stand for 5 minutes
4. Fold a circular filter in half 'twice' and open it up to form a cone. Place it in the soil suspension as far as possible. The filtration will take place from the outside of the filter to the inside.
5. As soon as sufficient filtrate accumulates in the filter, use the small pipette to transfer the soil extract onto the sensor of the LAQUA meter.
6. Read the value from the digital display after it has stabilized (30 - 45 sec.). Subtract 34 from the display value. This accounts for the 34 ppm NO_3^- in the extractant solution. For lbs/acre, multiply by 4 for a sampling depth of 12 inches. Note: For soils very low in nitrate, it is possible to get sensor readings less than 34.
7. Rinse sensor and blot dry. Display should read close to "0" with distilled water on it, if not rinse again.

COLLECTING TISSUE SAP

When conducting a test on plant materials, the biggest source of error is due to sampling. This error results when a sample is not representative of the source. Follow these steps to gather and care for your sample:

1.) Do not sample plants which show obvious signs of nutrient deficiency or damage from disease, insects, or chemicals unless these plants are the subject of a study. Plants which have been under stress for a period of time may not give a true picture of the nutrient status of the field.

2.) The leaves or parts of leaves selected should be of the same age and relative position on the plant. The most recently matured leaves should be used. These are the leaves that have stopped expanding in size. The petiole or leaf stem of the leaf or appropriated plant material should be used for the test.

3.) A minimum of 25 petioles or leaves should be collected. This is enough to represent a five to ten acre field if the field is judged to be uniform. Chop up the petioles and mix and sub-sample these pieces for testing. Crops with small, dry petioles, such as strawberries require much larger samples to get enough sap compared to fleshy crops such as tomatoes. Store whole petioles, not leaves, at room temperature for up to 1½ hours or on ice for up to eight hours. Cold petioles should be warmed to room temperature before taking a measurement.

4.) Depending on how succulent the petiole is, use a handheld or hydraulic plant sap press (p. 29) to squeeze sap from the petioles.

PREPARING SOIL-LESS MEDIA

Sample collection

1. Collect sample just before plants are irrigated.
2. Avoid the top layer of media with no roots.
3. Collect root media from the bottom $\frac{2}{3}$ of the pot.
4. Take samples from 10 or more plants distributed in the sample population.
5. When a sufficient amount of root media is collected, mix the sample.

Sample Preparation and Analysis

1:2 Extraction method

Measure a known volume of root media in a beaker or cup (usually 50 to 100 ml or $\frac{1}{4}$ to $\frac{1}{2}$ cup). Fill firmly so it is compressed as it was in the pot. Be consistent when measuring. DO NOT lightly fill or heavily pack the beaker. Place the sample into a cup or beaker.

Add 2 equal volumes of distilled water into the cup, mix the sample and wait 10 minutes. Measure the nitrate after sieving out the large particles. The nitrate level can be read directly from the slurry.

Saturated media extract method

Place 300 to 500 ml (1 to 2 cups) of root media sample in a cup or beaker.

Slowly add distilled water, constantly stirring the sample with a spatula or knife. Add enough distilled water so that the sample behaves like a paste with the surface glistening with water, but with no free water on the surface of the sample.

After 15 minutes, add more water if needed.

Extract the solution from the media using a pipette, Buchner funnel, side arm, flask and vacuum pump, filter bag or sieve. Make any additional measurements (such as EC) using the extracted solution. Table 2 gives a general idea of the nitrate levels to look for in the extracted solution.

Media Type	ppm NO₃⁻-N in extract
Seedlings	40 - 70
Young pot and foliage plants	50 - 90
Pot and bedding plants-growing on	80 - 160
Roses, mums or snapdragons in ground or raised beds	120 - 200
Lettuce and tomatoes in ground beds	125 - 225
Celery transplants	75 - 125

Table 2: Interpretation of Greenhouse Soils: Desirable NO₃⁻-N concentrations in saturated media extract.

SPECIFICATIONS

Principle	Ion electrode method
Readout	4-digit LCD digital display
Reproducibility	±10% of indication value
Measurement Range	14 to 1400 ppm NO ₃ ⁻ - N 62 to 6200 ppm NO ₃ ⁻
Operating Temperature	5 to 40 °C
Operating Humidity	maximum 85% RH
Calibration	1-pt 34 ppm NO ₃ ⁻ -N or 450 ppm NO ₃ ⁻ -N 2-pt 34 and 450 ppm NO ₃ ⁻ -N
Weight	52g (approx. 1.8 oz)
Power	2 - CR 2032 batteries
Auto Power OFF	30 seconds
Dimensions	164mm x 29mm x 20mm (6.5" x 1.1" x 0.8")
Sample volume	0.3 to 2.0ml
Battery Life	Approximately 400 hours of continuous use.
Water Resistance	Ip67. No failure when immersed in water at a depth of 1m for 30 minutes. Product can <u>not</u> be used underwater.

SOIL TEST KIT ACCESSORIES

Description	#2330 Replenishment Kit
Std. Solution 450ppm NO ₃ ⁻ -N (30ml)*	1
Extractant 34ppm NO ₃ ⁻ -N (1 Liter)*	2
Cups - 8oz.	3
Measuring Spoon (29.5 cc)	1
Pipet	1
Filter Papers	30

* Calibration solutions in soil test kits include AlSO₄



Hydraulic Plant Sap Press
(item #2720)



Handheld Plant Sap Press
(item #2725)

**PETIOLE NO₃-N SUFFICIENCY LEVELS
FOR DRIP-IRRIGATED VEGETABLES**
(SOURCE: UC-DAVIS)

Crop	Growth Stage	Petiole NO ₃ ⁻ -N concentration	
		Dry Tissue	Fresh Sap
Broccoli	Mid growth	10,000 - 20,000	1000 - 1600
	Button formation	8000 - 15,000	800 - 1200
	Preharvest	5000 - 8000	600 - 1000
Cabbage	Cupping	*	1200 - 1500
	Early heading	*	1000 - 1200
	Mid heading	*	700 - 900
Canteloupe	Early flower	12,000 - 15,000	1000 - 1600
	Fruit bulking	8000 - 10,000	800 - 1000
	First harvest	4000 - 6000	700 - 800
Cauliflower	Mid growth	*	1000 - 1600
	Curd development	*	700 - 1000
	Preharvest	*	500 - 800
Celery	Mid growth	7000 - 10,000	600 - 800
	Preharvest	6000 - 10,000	400 - 600
Lettuce	Early head formation	7000 - 10,000	400 - 600
	Preharvest	6000 - 8000	300 - 500
Onion	Bulbs 0.5-1.5 in.	*	350 - 500
Pepper	Vegetative growth	7000 - 10,000	900 - 1200
	Early flower/fruit	5000 - 8000	700 - 1000
	Fruit bulking	5000 - 8000	700 - 1000
	Preharvest	5000 - 7000	700 - 900
Potato (Russet Burbank)	Early vegetative	17,000 - 22,000	1300 - 1600
	Mid tuber/bulking	11,000 - 15,000	900 - 1200
	Late tuber/maturation	6000 - 8000	550 - 700
Sweet Corn	Entire season	*	600 - 700
Tomato	Vegetative growth	10,000 - 14,000	700 - 900
	Early flower/fruit	9000 - 12,000	600 - 800
	Fruit bulking	6000 - 8000	500 - 700
	Preharvest	4000 - 7000	400 - 600
Watermelon	Early flower	12,000 - 15,000	1000 - 1600
	Fruit bulking	8000 - 15,000	700 - 900
	Fruit harvest	5000 - 8000	500 - 700

PETIOLE NO₃⁻-N SUFFICIENCY LEVELS

(SOURCE: UNIVERSITY OF FLORIDA)

Crop	Growth Stage	NO ₃ ⁻ -N (ppm) Fresh Sap
Cucumber	First blossom	800 - 1000
	Fruits 3-inches long	600 - 800
	First harvest	400 - 600
Broccoli & Collards	Six-leaf stage	800 - 1000
	Just prior to harvest	500 - 800
	At first harvest	300 - 500
Summer Squash	First blossom	900 - 1000
	First harvest	800 - 900
Muskmelon	First blossom	1000 - 1200
	Fruits 2-inches long	800 - 1000
	First harvest	700 - 800
Tomato (field)	First buds	1000 - 1200
	First open flowers	600 - 800
	Fruit 1-inch diameter	400 - 600
	Fruit 2-inch diameter	400 - 600
	First harvest	300 - 400
	Second harvest	200 - 400
Bell Pepper	First flower buds	1400 - 1600
	First open flowers	1400 - 1600
	Fruits half-growth	1200 - 1400
	First harvest	800 - 1000
	Second harvest	500 - 800
Eggplant	First fruit (2-inches long)	1200 - 1600
	First harvest	1000 - 1200
	Mid harvest	800 - 1000
Potatoes	Plants 8-inch tall	1200 - 1400
	First open flowers	1000 - 1400
	50% of flowers open	1000 - 1200
	100% of flowers open	900 - 1200
	Tops falling over	600 - 900

PETIOLE NO₃⁻-N SUFFICIENCY LEVELS (CONT.)

(SOURCE: UNIVERSITY OF FLORIDA)

Crop	Growth Stage	NO₃⁻-N (ppm) Fresh Sap
Annual Hill	November	800 - 900
Strawberries	December	600 - 800
(October	January	600 - 800
planting)	February	300 - 500
	March	200 - 500
	April	200 - 500
Watermelon	Vines 6-inches long	1200 - 1500
	Fruit 2-inches long	1000 - 1200
	Fruits half mature	800 - 1000
	First harvest	600 - 800

**PETIOLE NO₃⁻-N SUFFICIENCY LEVELS FOR POTATOES
(SOURCE: UNIV. WISCONSIN-MADISON)**

Optimum range of nitrate-nitrogen concentrations (dry weight and sap basis) in potato petiole at various stages of growth

Growth Stage (days after emergence)	Norkotah, Norland, Atlantic, Kennebec	Shepody, R. Burbank, Snowden	Onaway Superior
	Dry Weight Basis (% NO₃⁻-N)		
30	2.5 - 2.8	2.0 - 2.3	2.3 - 2.5
40	2.3 - 2.5	1.7 - 2.2	2.0 - 2.3
50	1.8 - 2.3	1.2 - 1.6	1.5 - 1.9
60	1.3 - 1.9	0.8 - 1.1	0.9 - 1.2
70	0.8 - 1.1	0.5 - 0.8	0.4 - 0.6
	Sap Basis (ppm NO₃⁻-N)		
30	1900 - 2100	1600 - 1800	1800 - 1900
40	1800 - 2000	1600 - 1700	1600 - 1800
50	1400 - 1800	1000 - 1300	1200 - 1500
60	1110 - 1500	700 - 900	500 - 1000
70	700 - 900	500 - 700	400 - 600

Values from the LAQUA can be converted to dry tissue calibration by using the equation:

$$\% \text{Dry Weight NO}_3^- \text{-N} = 0.00142 (\text{ppm sap NO}_3^- \text{-N}) - 0.21$$

**PETIOLE NO₃⁻-N SUFFICIENCY LEVELS RUSSET BUR-
BANK POTATOES
(SOURCE: UNIV. OF MINNESOTA)**

Growth Stage	Petiole NO ₃ ⁻ -N (ppm)	
	Dry Tissue	Fresh Sap
Early Vegetative/tuberization	17,000 - 22,000	1300 - 1600
Mid tuber growth/bulking	11,000 - 15,000	900 - 1600
Late tuber growth/maturation	6,000 - 8,000	550 - 700

PETIOLE NO₃-N SUFFICIENCY LEVELS

(SOURCE: MICHIGAN STATE UNIVERSITY)

The following guidelines are based on one year's research results and will be revised as necessary based on future research findings. Readings taken on youngest fully extended petiole.

Carrots

Adequate petiole sap nitrate concentration

Carrot shoulder diameter (in.)	Nitrate-N (ppm)	Nitrate (ppm)
Prior to sizing	750+	3,300+
0.00 - 0.25	550+	2,420+
0.25 - 0.50	450+	1,980+
0.50 - 0.75	300+	1,320+
0.75 - 1.50	250+	1,100+
> 1.50	200+	880+

Celery

Adequate petiole sap nitrate concentration

Weeks after transplant	Nitrate-N (ppm)	Nitrate (ppm)
0 - 5	800+	3,520+
5 - 6	725+	3,190+
6 - 7	650+	2,860+
7 - 8	575+	2,530+
8 - 9	500+	2,200+
9 - 10	425+	1,870+
10 - 11	350+	1,540+
11+	275+	1,210+

Onions

Adequate petiole sap nitrate concentration

Growth Stage	Nitrate-N (ppm)	Nitrate (ppm)
Up to 5 leaves	800+	2,520+
5 to leaves	600+	2,640+
Bulb initiation	300+	1,320+
Bulb bulking	250+	1,110+

PRE-SIDEDRESS NITRATE (PSNT) SOIL TEST INTERPRETATION

University of Tennessee

<17	ppm NO ₃ ⁻ -N Low
17 - 25	ppm NO ₃ ⁻ -N Low
>25	ppm NO ₃ ⁻ -N Low

Rutgers Cooperative Extension

PSNT Soil Test Level (ppm NO ₃ ⁻ -N)	Sidedress N Recommendation
1 - 15	160
16 - 20	120
21 - 25	80
26 - 30	40
31+	0

University of Wisconsin

PSNT result (ppm N)	Soil Potential*	
	Very High/High	Medium/Low
<10	160	120
11 - 12	150	80
13 - 14	125	80
15 - 17	100	40
18 - 20	60	40
>21	0	0

* consult WMEX pub. A2809

Pennsylvania Nitrogen Soil Test Recommendation (Lbs N/Acre)

(Source: Penn State University)

Soil Test Level (ppm NO ₃ ⁻ -N)	Corn Yield Goal				
	100	125	150	175	200
0 - 10	100	130	160	190	220
11 - 15	75	100	125	150	150
16 - 20	50	75	100	125	125
21 - 25	25	50	75	100	100
25+	0	0	0	0	0

Note: Check you county extension office for updates

Frequently asked questions

Question	Answer
How long is the sensor's service life?	It depends on measurement samples and conditions. It should be approx. 1500 measurements for typical samples. Note that sensor deterioration and failure are not included in the warranty.
How can I check the sensor's condition?	Perform two-point calibration. If calibration error occurs, the sensor is deteriorated. Replace the sensor.
What shall I do if two-point calibration is failed?	Dirt in the response membrane and liquid junction is the main cause of calibration failure. Clean the sensor thoroughly with water, then gently wipe off the response membrane with soft cloth or paper. If calibration is still failed after this, replace the sensor.
What factors interfere measurement?	Strong acids and strong alkalis influence measurement results. Measure within the range from 4 pH to 12 pH. Chloride ions (Cl ⁻), oils, and fats influence measurement results. Therefore, a sample of seashore soil or fatty crop may cause measurement errors. Also, a sample of significantly high conductivity may cause measurement errors.
How can I eliminate or reduce the measurement interference?	Diluting the sample to a concentration within the measurable range can sometimes reduce measurement interference. An ion chromatography precolumn (e.g. OnGuard II Ag precolumn manufactured by Thermo Fisher Scientific Inc.) is helpful to remove Chloride ions (Cl ⁻).
Are there any helpful tips or precautions to be aware for measurement?	Use the light shield cover to avoid direct sunlight during measurement because the sensor is affected by light. If the light shield cover is unavailable, for example, when a sampling sheet holder cover is attached, shield the flat sensor from light with an alternative.
	When the sample amount is enough, washing the sensor twice or so with the sample allows more accurate measurement.
	Residue between the light shield cover and flat sensor prevents accurate measurement. Before measurement of the next sample, clean the sensor with tap water and remove moisture.

Question	Answer
Can I measure high- or low-temperature samples?	This product can not measure a sample with a temperature outside the meter's operating temperature range (5°C to 40°C). The difference between the sample temperature and ambient temperature increases the measurement error. Perform measurement after the sample reaches the ambient temperature.
Can I prepare standard solutions myself?	Prepare standard solutions by dissolving potassium nitrate in ion-exchanged water to the specified concentration.
The measured value does not change after changing the sample.	If MEAS lights steadily, the measured value is locked. Press the MEAS switch to unlock the value. If the value does not change after unlocking, the sensor may be damaged. Replace the sensor.
The temperature alarm icon blinks during measurement.	The measuring environment temperature may not meet the specified operating temperature (5°C to 40°C). When the environment temperature is within the specified range and the alarm icon blinks, replace the sensor.
The power is not turned ON.	Check that the batteries are inserted properly. If the batteries are low, replace them both with new ones at the same time.
Er1 is displayed right after power ON.	The internal IC in the meter may defect. After Er1 is displayed, the meter enters the initialization mode automatically and Init and ☺ appear. Press the CAL switch for over 2 seconds to execute initialization, and then turn OFF and ON again. If Er1 is still displayed after the initialization, the internal IC in the meter defects. Replace the product with new one (the meter can not be repaired).
Er2 is displayed right after power ON.	The internal IC in the meter defects. Replace the product with new one (the meter can not be repaired).
Er3 is displayed right after power ON.	The internal IC in the meter defects. Replace the product with new one (the meter can not be repaired).

Question	Answer
How can I return all the settings of the special setting mode to the default settings?	Perform initialization

WARRANTY

This product is warranted to be free from defects in material or workmanship for one year from the date of purchase. During the warranty period Spectrum will, at its option, either repair or replace products that prove to be defective. This warranty does not cover damage due to improper installation or use, lightning, negligence, accident, or unauthorized modifications, or to incidental or consequential damages beyond the Spectrum product. Before returning a failed unit, you must obtain a Returned Materials Authorization (RMA) from Spectrum. Spectrum is not responsible for any package that is returned without a valid RMA number or for the loss of the package by any shipping company.



This equipment has been manufactured for
Spectrum Technologies, Inc.
3600 Thayer Court
Aurora, IL 60504 USA

The Manufacturer's **DECLARATION OF CONFORMITY** is on file at the above address, and certifies conformity to the following:

Model Number: 2305GL
Description: Nitrate Meter
Type: Electrical Equipment for Measurement, Control, and Laboratory Use

Directive: 2004/108/EC
Standards: EN 61326-1 (2006), Class B

Douglas L. Kieffer,
Soil/Water Products Manager

March 4, 2009

Spectrum[®] ***Technologies, Inc.***

**3600 Thayer Court
Aurora, IL 60504
(800) 248-8873 or (815) 436-4440
Fax (815) 436-4460
E-Mail: info@specmeters.com
www.specmeters.com**